

# Technical application guide OPTOTRONIC® LED drivers for indoor application

---

## Contents

---

### 1 Features and segmentation

---

### 2 Flexible current setting for window drivers via LEDset (OTi DALI and OTi)

---

### 3 DALI dimming curves (power consumption depending on dimming level)

---

### 4 Touch DIM® and corridor function for OPTOTRONIC® DALI

---

### 5 Combination of LED module and LED driver in constant-current systems

---

### 6 The OSRAM Matchmaker – LED modules and system compatibilities

---

### 7 Planning, installation and operation

---

### 8 Insulation types

---

### 9 Dimming principles

---

### 10 Ripple current and “light modulation”

---

### 11 Emergency lighting with central and local battery systems

---

### 12 Abnormal conditions

---

### 13 Installation notes

---

### 14 Standards for LED drivers, LED modules and LED luminaires

---

#### **Please note:**

All information in this guide has been prepared with great care. OSRAM, however, does not accept liability for possible errors, changes and/or omissions. Please check [www.osram.com](http://www.osram.com) or contact your sales partner for an updated copy of this guide. This technical application guide is for information purposes only and aims to support you in tackling the challenges and taking full advantage of all opportunities the technology has to offer. Please note that this guide is based on own measurements, tests, specific parameters and assumptions. Individual applications may not be covered and need different handling. Responsibility and testing obligations remain with the luminaire manufacturer/OEM/application planner.

# Technical application guide OPTOTRONIC® LED drivers for indoor application

## 1 Features and segmentation

### Features

Having become as popular as fluorescent ECGs, HID ECGs or electronic transformers, LED drivers fulfill similar requirements and thus allow for a highly efficient and reliable illumination in shops, offices and industrial areas.

Typical required features of LED drivers are:

- **CLO (Constant Lumen Output) function**  
To ensure a constant light level over the lifetime of the LED luminaire and to extend the LED lifetime.
- **DALI interface**  
For intelligent integration into building management systems.
- **Touch DIM® function**  
Simple and cost-efficient interface for smaller lighting installations.
- **Permitted switching cycles**  
OPTOTRONIC® DALI LED drivers and OSRAM LED modules are specified for a minimum of 100 000 switching cycles. When switching 50 times a day, a minimum of 5 years of reliable operation is possible.
- **EL sign**  
Reliable operation in emergency installations in luminaires according to EN 605982-2-22 with central or group batteries.
- **Low ripple**  
High light quality and camera-proof light.
- **Industry driver**  
For reliable long-term operation in industrial areas.
- **Window driver**
  - Large operating window to reduce number of LED driver types in luminaire manufacturing and maintenance.
  - Joint operation of LED modules of different manufacturers possible.
  - Future-proof drivers for new LED generations.
  - Output current settable via LEDset, resistor or Tuner4TRONIC® (software) and DALI magic (hardware).
- **LEDset**  
Standardized interface for correct current setting of window drivers.
- **Hybrid dimming**  
Amplitude dimming (between 100 and 30% of the luminous flux) for high energy efficiency and PWM dimming (between 30 and 1% of the luminous flux) for same light and light color even at lower dimming levels.

### Hybrid dimming

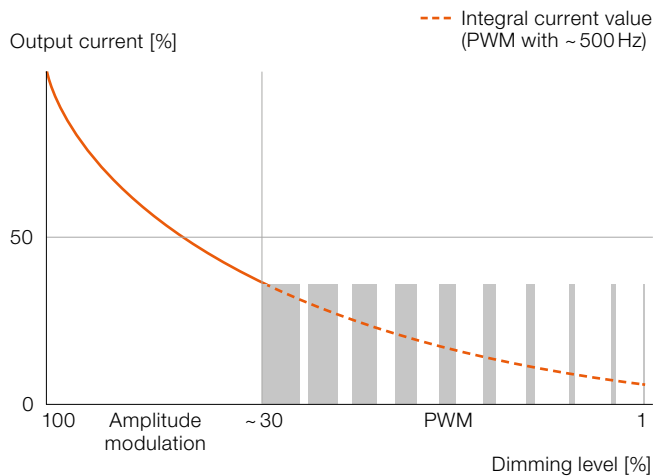

### OTi DALI operating range (non-isolated)

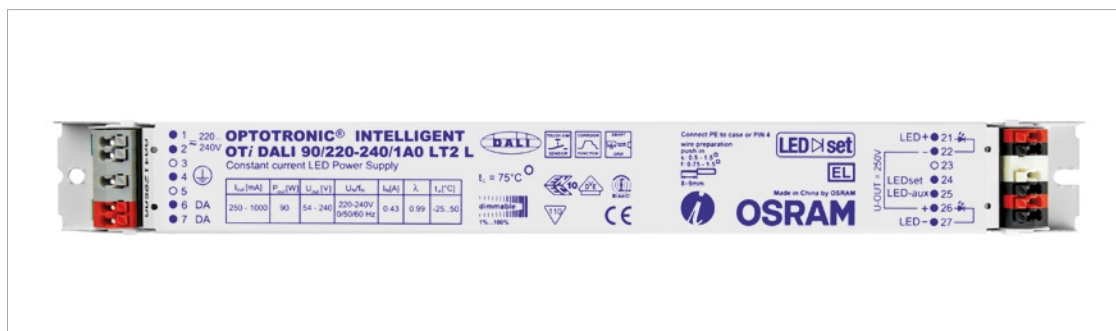
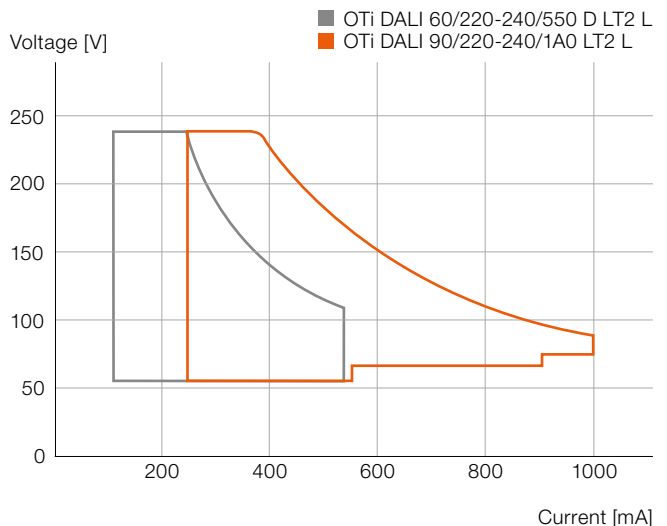

OPTOTRONIC® Intelligent (OTi) DALI driver

### Segmentation





OSRAM offers two main families of LED drivers:  
OPTOTRONIC® Linear and OPTOTRONIC® Compact.

#### Main characteristics of OPTOTRONIC® Linear LED drivers

- All housings with a cross section of 30x21 mm
- Fully programmable and digital platform with OPTOTRONIC® Intelligent DALI window drivers

- 3 ON/OFF product families: OPTOTRONIC® Intelligent window drivers, OPTOTRONIC® FIT with 3 current settings, OPTOTRONIC® FIT with fixed output currents
- SELV and non-isolated versions: many possible combinations with LED modules

### OPTOTRONIC® Linear driver portfolio

					
	<b>Dimmable (DALI):</b> OPTOTRONIC® Intelligent Window driver (SELV)	<b>Dimmable (DALI):</b> OPTOTRONIC® Intelligent Window driver (non-isolated)	<b>Non-dimmable:</b> OPTOTRONIC® Intelligent Window driver (non-isolated)	<b>Non-dimmable:</b> OPTOTRONIC® FIT Three currents settable (SELV)	<b>Non-dimmable:</b> OPTOTRONIC® FIT Fixed output (non-isolated)
<b>Dimming</b>					
Comfort dimming AM+PWM	■	■			
Lowest dimming level	1 %	1 %			
DALI DT6	■	■			
Touch DIM®/Touch DIM® Sensor	■	■			
Corridor function	■	■			
<b>DC operation</b>					
Emergency lighting*	■	■	■	■	■
Fixed DC level			■ (on/off by current modulation)	■	■
Adjustable DC level	■ (by software)	■ (by software)			
<b>Output current</b>					
Adjustable	■ (by software and/or LEDset resistor)	■ (by software and/or LEDset resistor)	■ (by LEDset resistor)	■ (CS)	
Current tolerances [%]	≤5**	≤5	≤5	≤20	≤10
Ripple at 100 Hz [%]	<1	<10	<10	<7	<10
<b>Functions and performances</b>					
Overtemperature protection	■	■	■	■	■
Energy efficiency	up to 91 %	up to 92 %	up to 92 %	up to 87 %	up to 90 %
CLO	■	■			
Stand-by losses [W]	<0.5	<0.3			
Input voltage range [V]	220-240	220-240	220-240	220-240	220-240
Min. number of switching cycles	150 000	150 000	150 000	150 000	150 000
Lifetime [h]**	100 000	100 000	100 000	100 000	100 000
T <sub>a</sub> range [°C]	-25...+50	-25...+50	-25...+50	-25...+50	-25...+50
Suitable for luminaire class****	I	I	I	I	I

\* According to IEC 61347-2-13

\*\* Version with <2 % available soon

\*\*\* Operation at max. T<sub>c</sub> -10K, maximum failure rate of 10 %

\*\*\*\* Special permission for class II luminaires possible on request

AM = Amplitude Modulation

PWM = Pulse Width Modulation

DT6 = DALI Device Type 6

CS = Current Setting

CLO = Constant Lumen Output

**Main characteristics of OPTOTRONIC® Compact LED drivers**

- 1 fully programmable and digital platform with OPTOTRONIC® Intelligent DALI
- 2 ON/OFF product families: OPTOTRONIC® FIT and OPTOTRONIC® ECO with 3 current settings
- OPTOTRONIC® ECO Phase Cut for dimming with trailing- and leading-edge phase-cut dimmers
- Many possible combinations with LED modules

**OPTOTRONIC® Compact driver portfolio**



**Dimmable (DALI):**  
OPTOTRONIC®  
Intelligent DALI

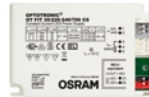

**Three currents  
settable:**  
OPTOTRONIC® FIT



**Three currents  
settable:**  
OPTOTRONIC® ECO



**Dimmable (PC):**  
OPTOTRONIC® ECO  
Phase Cut

**Dimming**

Comfort dimming AM+PWM	■ AM+PWM			■ AM
Lowest dimming level	1 %			10 %
Type of dimming	■ DALI DT6			■ Trailing- or leading-edge phase control
Touch DIM®	■			
Corridor function	■			
Emergency lighting*	■	■		
Fixed DC level		■		
Adjustable DC level	■ (by software)			
Adjustable output current	■ (by software and/or LEDset resistor)	■ (CS)	■ (CS)	
Current tolerances [%]	5	10	5	10
Ripple at 100 Hz [%]	<2	<5	<20...<30	<25...<35

**Functions and performances**

Overtemperature protection	■	■	■	■
Hot plug-in	■	■		
CLO	■			
Stand-by losses [W]	<0.5			
Input voltage range [V]	220-240	220-240	220-240	220-240
Min. number of switching cycles	150 000	150 000	100 000	100 000
Lifetime [h]**	100 000	100 000	50 000	50 000
T <sub>a</sub> range [°C]	-20...+50	-25...+50	-20...+50	-20...+50
Suitable for luminaire class	I + II	I + II	I + II	I + II

\* According to IEC 61347-2-13

\*\* Operation at max. T<sub>c</sub> -10K, maximum failure rate of 10 %

AM = Amplitude Modulation  
 PWM = Pulse Width Modulation  
 DT6 = DALI Device Type 6  
 CS = Current Setting  
 CLO = Constant Lumen Output



CABLE CLAMP A-Style



CABLE CLAMP B-Style TL



CABLE CLAMP B-Style



CABLE CLAMP D-Style

OPTOTRONIC® Compact indoor drivers from OSRAM can easily be retrofitted with suitable cable clamps, if required. This way, in case an independent installation is required, the same driver can be used with the additional cable clamp. For through-wiring, the TL version is available.

# Technical application guide OPTOTRONIC® LED drivers for indoor application

## 2 Flexible current setting for window drivers via LEDset (OTi DALI and OTi)

## Current setting for window drivers via LEDset interface

### LEDset interface

OTi DALI and OTi window drivers offer the adjustment of the LED module current in small current steps. Therefore, adjustment of the required LED module current is done easily via an external resistor ( $R_{set}$ ).



The LEDset interface is a standardized LED module interface for setting the right maximum output current and establishing an easy-to-implement and low-cost temperature protection for the connected LED modules.

Today, this interface is used by the majority of European manufacturers of LED drivers. The benefits of a LEDset interface are:

1. Very easy combination of LED modules and LED window drivers
2. Plug & play current setting of LED drivers
3. Same resistors/resistor values used across vendors
4. Standardized, future-proof solution

LEDset gives the possibility to manually set the LED current of LED window drivers without the need for additional programming. This multi-vendor interface is suitable for LED modules connected in parallel or series.

LEDset is based on a 3-wire connection between the LED driver and one or more LED modules. Only one additional wire, besides the two LED current supply wires, is used for transferring information from the LED module(s) to the LED driver, provided the  $R_{set}$  is mounted on the LED module. Alternatively, a standard resistor can be put directly into the driver's input connector (LEDset and LED-aux; see option 1).

### Flexible current setting via LEDset mode (resistor)

There are three options to place the resistor:

**Option 1:** Typically between LEDset and LEDset-aux



**Option 2\*:** Alternatively between LEDset and LED-; LEDset-aux and LED- are connected/one potential



**Option 3:** On the LED module

Luminaire 1

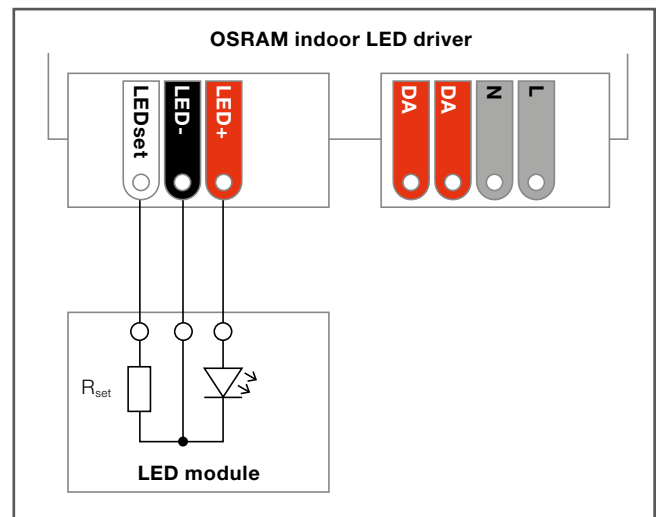

Resistor on the LED module

Luminaire 2

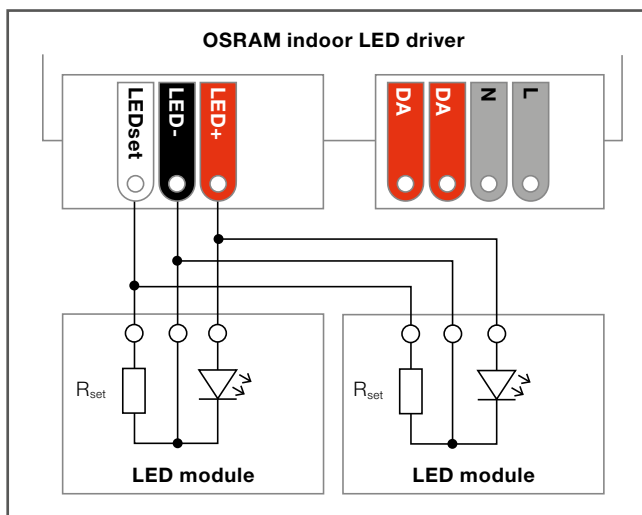

Luminaire 3

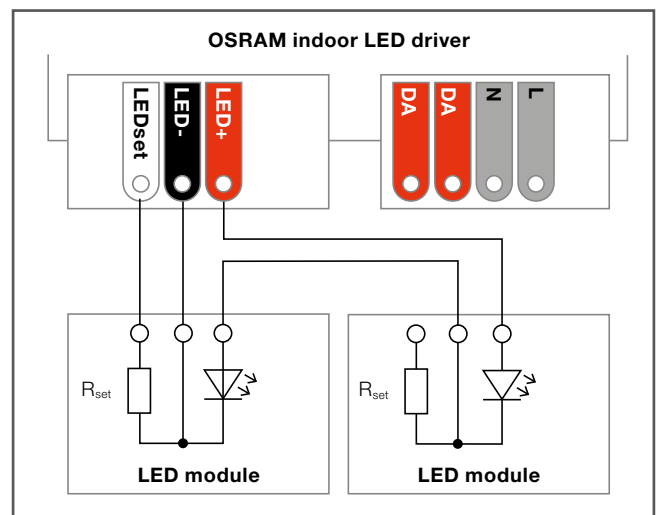

OSRAM indoor LED driver connected to LED modules in parallel or in series

\* For OTi (DALI) 60 and OTi (DALI) 90, option 2 is not recommended as it is not precise enough.



The LEDset interface works with a 5V constant-voltage source within the LED driver. The LEDset interface measures the current that flows from the 5V constant-voltage source through the R<sub>set</sub> resistor(s).

Therefore, the correct LEDset resistor value can be calculated by the following formula:

$$R_{set} [\Omega] = (5V / I_{out} [A]) \times 1000$$

The output current I<sub>out</sub>, selected via the R<sub>set</sub> within the valid LEDset range, must match the driving current of the LED module and the nominal current range of the used LED driver. In the above condition, the maximum nominal LED driver current I<sub>out,max</sub> is set by the minimum R<sub>set</sub> value (R<sub>set,min</sub> = 5V/I<sub>max</sub> x 1000) and the minimum nominal LED driver current I<sub>out,min</sub> is set by the maximum R<sub>set</sub> value (R<sub>set,max</sub> = 5V/I<sub>min</sub> x 1000). The interface behavior follows the table below.

### LEDset characteristics

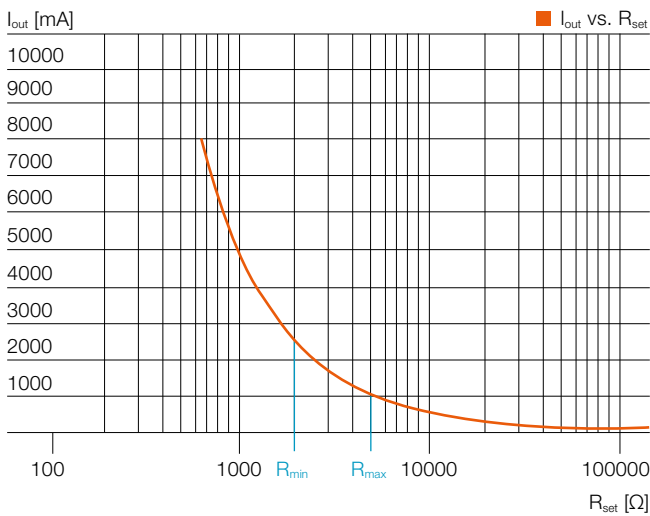

The figure above shows the standardized I<sub>out</sub>/R<sub>set</sub> curve. R<sub>min</sub> and R<sub>max</sub> depend on the individual LED window driver.

### Interface behaviors

R <sub>set</sub> selection	I <sub>out</sub>
R <sub>set</sub> < R <sub>set,min</sub>	For I <sub>out</sub> behavior, see product datasheet
R <sub>set,min</sub> < R <sub>set</sub> < R <sub>set,max</sub>	$I_{out} [A] = \frac{5V}{R_{set} [\Omega]} \times 1000$
R <sub>set</sub> > R <sub>set,max</sub>	For I <sub>out</sub> behavior, see product datasheet

In case that there is no R<sub>set</sub> connected (R<sub>set</sub> > R<sub>set,max</sub>), the factory default current is typically 50% of the minimum nominal current. As soon as the LED driver detects a resistor, the output current is adjusted according to the LEDset resistor coding.

The OSRAM R<sub>set</sub> calculator, which is integrated into the OSRAM Matchmaker for LED module/LED driver combinations, helps you to find the correct resistor values. For more details, please see the chapter “The OSRAM Matchmaker – LED modules and system compatibilities”.

**INPUT DATA**

Device selection: Select Module & Driver

Module/driver combination:

Module temperature at T<sub>C</sub> point: 47 °C

Target setting (define one):

target current: 700 mA

target flux: 1230 lm

System setup:

no parallel modules: 1

no modules in series: 1

**OUTPUT DATA** PL-CN111-1200-930-24D/40D-G1

	OTi DALI 25/220-240/700 LT2					FLEX DRIVER	
	ECG min	Sys min	Sys nom	Sys max	ECG max	target current	target flux
ECG current (mA)	180	450	700	700	700	700	700
temperature (°C)	-	47	47	47	47	47	47
Modules flux (lm)	-	843	1230	1230	1230	1230	1230
Modules voltage (V)	-	24,4	25,7	25,7	25,7	25,7	25,7
Modules power (W)	-	11,0	18,0	18,0	18,0	18,0	18,0
Modules efficacy (lm/W)	-	77	68	68	68	68	68
ECG efficiency full load (%)	-	86%	86%	86%	86%	86%	na
System power (W)	-	12,7	20,9	20,9	20,9	20,9	na
System efficacy (lm/W)	-	66	59	59	59	59	na
ECG Rset (kOhm)	27,8	11,1	7,1	7,1	7,1	7,1	0,0

**DIAGRAMS**

The OSRAM Matchmaker shows the output current and the corresponding R<sub>set</sub> value

Ready-to-use resistors are available from electronics distributors as well as BJB. For non-isolated LED window drivers, the terminals of the  $R_{set}$  are connected to mains, therefore an additional isolation is required.

### Isolated resistor from BJB for non-isolated drivers



### Current setting via programmable interface (Tuner4TRONIC®)

In the Tuner4TRONIC® software, the programming of the current is called “Fixed current mode”.

#### Fixed current mode (via programmable interface)

For OTi DALI LED drivers where additional parameter settings such as the CLO function can be programmed, current setting is done via a programmable interface to reduce luminaire manufacturing time.

To use the fixed current mode, it has to be selected in the Tuner4TRONIC® software. The minimum and maximum rated output currents are displayed according to the selected LED driver. The output current of the LED driver can be set by changing the value in the “Operating Current” field. Current setting is only possible within the specified current range.

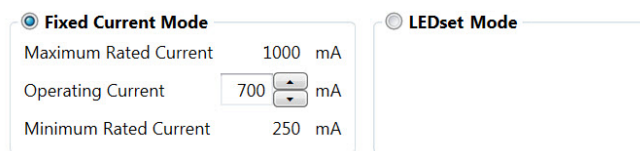

Note: LEDset2 interface disabled.

Fixed current mode adjustment/LEDset mode disabled

For further details, please refer to the LEDset application guide, which can be downloaded at [www.osram.com/ledset](http://www.osram.com/ledset).

#### Default current setting mode (ex factory)

Window driver (ex factory):

As soon as the LED driver detects a resistor, the output current is adjusted according to the LEDset resistor coding.

When the window driver has been programmed in the fixed current mode, the LEDset mode remains disabled even if a resistor is connected.

#### Warning:

- Tuner4TRONIC® may be used by electrically qualified personnel **only**.
- To achieve a reliably working LED system, please read the chapters 5, 6 and 7 of the “Technical application guide OPTOTRONIC®” carefully (“5. Matching of LED modules and LED drivers”, “6. Matchmaker”, “7. Planning, installation, operation”).
- For a reliably working LED system, the LED module current **must** be adjusted correctly:
  - Either via “Fixed current mode” with T4T
  - Or via “LEDset2 mode”, i.e. by using the correct LEDset resistor
- The maximum  $T_c$  temperature of the LED module must not be exceeded during the adjustment.
- **Wrong** currents or currents **accidentally set too high** result in too high temperatures in the LED module and may, at worst, lead to a **combustion of the LED module**.

# Technical application guide OPTOTRONIC® LED drivers for indoor application

3 DALI dimming curves (power consumption depending on dimming level)

### DALI dimming curves

IEC 62386 defines the dimming range of a DALI controller from 0.1 to 100%.

The dependance of the relative luminous flux X (n) on the digital 8-bit DALI value n is described by the following correlation:

$$X(n) = 10^{\frac{n-1}{253} - 1} \%$$

Where the following applies:

$$\left| \frac{X(n) - X(n+1)}{X(n)} \right| = 2.8\% = \text{Const.}$$

This results in the following graphical association:

- Logarithmic curve (factory setting) used for standard applications (e.g. daylight control)
- Linear curve: LED drivers according to IEC 62386-207 and other drivers such as OTi DALI additionally provide a linear dimming curve, which is only used in special cases, particularly for easier adjustment of RGB colors in RGB dimming applications

Switching between the curves is possible with Tuner4TRONIC®, DALI Wizard or other tools.

### Logarithmic and linear DALI dimming curve

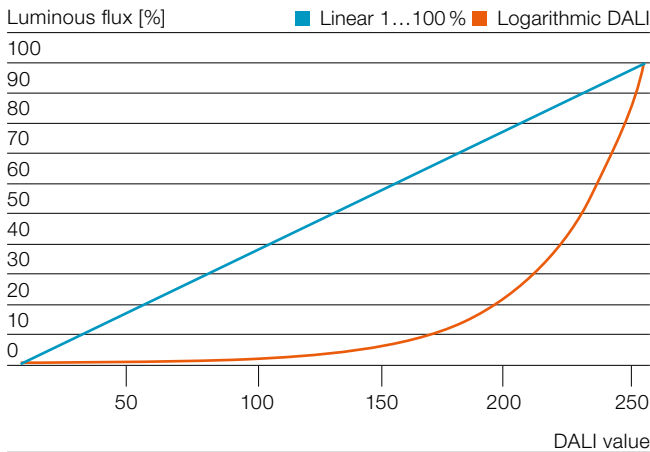

### Short overview of the most important DALI dimming values

Luminous flux [%]	Logarithmic	Linear
0	0	0
0.1	1	–
0.5	60	1
<b>1.0</b>	<b>85</b>	<b>3</b>
3	126	8
5	144	13
<b>10</b>	<b>170</b>	<b>26</b>
20	195	51
30	210	76
40	220	102
50	229	127
60	235	153
70	241	178
80	246	203
90	250	229
100	254	254

In first estimation, the luminous flux corresponds to the relative electrical power that the LED driver delivers to the LED module. In principle, the DALI standard defines 0.1 % as the lowest luminous flux, which corresponds to the relative DALI value 1. Not all DALI drivers can dim down to 0.1 %. To ensure that the transitions from one digital level to the next are not visible, OSRAM DALI drivers feature digital “smoothing”. This is an additional function of OTi DALI drivers for increasing lighting comfort and is not part of the DALI standard.

### System energy consumption and dimmer setting

Because there is an approximately linear relationship between the power consumption of the DALI-DIM systems (LED module and driver) and the dimmer setting, the power consumption PN(d) can be calculated for each dimmer setting d (in percent) based on the values PN100% (100 % of nominal power, PN = Power Nominal) and PN1% (1 % of nominal power):

$$PN(d) = PN1\% + \frac{PN100\% - PN1\%}{99\%} \cdot (d - 1\%)$$

### Linear correlation: Dimming level and system power consumption

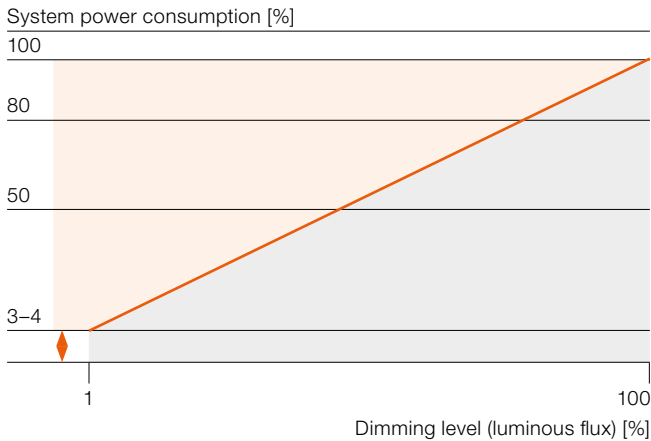

### Dimming range and lowest dimming level of a DALI LED driver

For the permitted dimming range and the lowest dimming level of a DALI LED driver, please refer to the corresponding product datasheets.

### CLO (Constant Lumen Output) function

The CLO function can be used to compensate the lumen decrease over the lifetime of the LED. To achieve a constant light output of the LED module, the LED driver can store the operating hours of the LED module and increase the output current to react on the light output drop. The benefits are:

- Energy and cost savings
- Longer lifetime of the LED module
- Same light output and same light color over the lifetime of the luminaire
- Better maintenance due to group change of LED modules

To set this feature according to the applied LED module, the Tuner4TRONIC® software can be used, for example, as shown in the figures below.

### Constant lumen programming table

Constant Lumen	Schedule										Savings
<input checked="" type="checkbox"/> Enabled	Output Level	70	75	80	85	90	92	95	100	%	
	Operating Time	0	30	50	60	70	80	90	100	kh	

### Constant lumen programming graph (operating time = 10 kh)

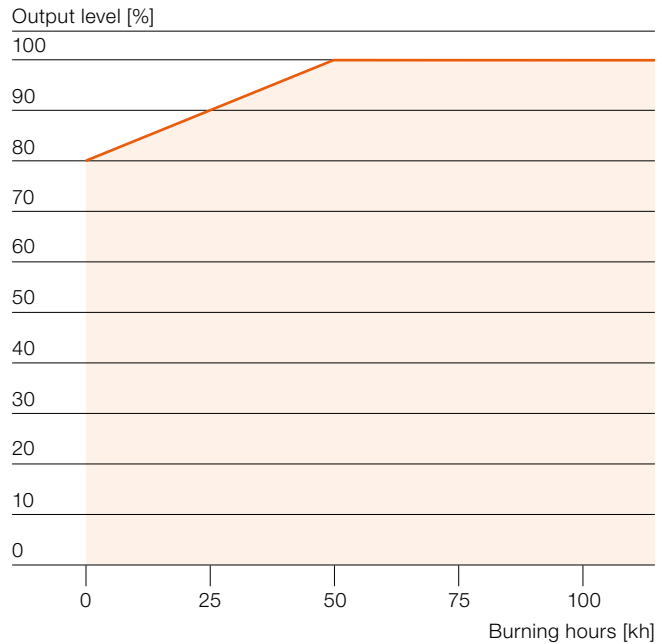

The output levels have to be monotonically increasing from the beginning.

**Warning:** The output level is indicated as a red number if the level is set higher than 100%. In this case, the reliability and safety of the module needs to be checked if the nominal operating current is exceeded. It is not possible to achieve a higher output current than the maximum nominal output current of the LED driver.

### Lamp operating counter

The LED driver monitors the operating hours of the connected LED module. Operating hours are only counted when the LED module is powered. The lamp operating time also has an influence on the CLO function. It can be set using the Tuner4TRONIC® software as shown in the figure below.

### (Lamp) Operating time

**(Lamp) Operating time**

Time  kh

For more details, see the Tuner4TRONIC® manual.

# Technical application guide OPTOTRONIC<sup>®</sup> LED drivers for indoor application

## 4 Touch DIM<sup>®</sup> and corridor function for OPTOTRONIC<sup>®</sup> DALI

### Touch DIM® – light dimming with standard push-buttons

With the Touch DIM® operation, smaller installations can be realized without a DALI controller.

When dimming with commercially available mains-compatible push-buttons, a fixed dimming value can be stored. For this, the push-buttons just have to be connected to the DALI drivers (see below).



#### Touch DIM® operation

- Switch the light on/off: Short press (<0.5 s)
- Dim the light: Long press (>0.5 s), the dimming direction is changed with each press
- Store the reference value: Double-click (press twice within 0.4 s) when the light is on
- Delete reference value: Double-click when the light is off

**Note:** Long press when the light is off: The LED module is switched on at the minimum dimmer setting and faded up until the switch is released.

#### Operating modes of Touch DIM® function

OSRAM OTi DALI LED drivers offer 2 operating modes for Touch DIM® operation. They differ in terms of switch-on behavior.

- **Touch DIM® mode 1\*** (default mode): The switch-on value is always the last dimming level before the light was switched off. After a mains voltage interruption, you get the same light level like before.
- **Touch DIM® mode 2:** The switch-on value is stored by double-clicking. After a mains voltage interruption as well, the DALI drivers dim to the stored light value. This means, after a short press of the push-button, the DALI drivers dim to this stored light value.

#### Switching between modes 1 and 2

Touch DIM® mode 1 is activated by double-clicking when the light is switched off. You can switch to mode 2 by double-clicking when the light is switched on.

#### \* Note:

Because of the different behaviors of QUICKTRONIC® QTi DALI and OPTOTRONIC® OTi DALI, they should not be dimmed with the same push-button.

Touch DIM® settings including controls and operating modes can be easily customized with the software DALI Wizard or Tuner4TRONIC®.

#### Touch DIM® installations for max. 20 DALI drivers and up to 25 m cable length

By just using simple standard push-buttons, i.e. without additional DALI controllers, the Touch DIM® function allows the dimming of up to 20 drivers with a total open DALI cable length of up to 25 m.

### OPTOTRONIC® Intelligent DALI (<25 m cable length)

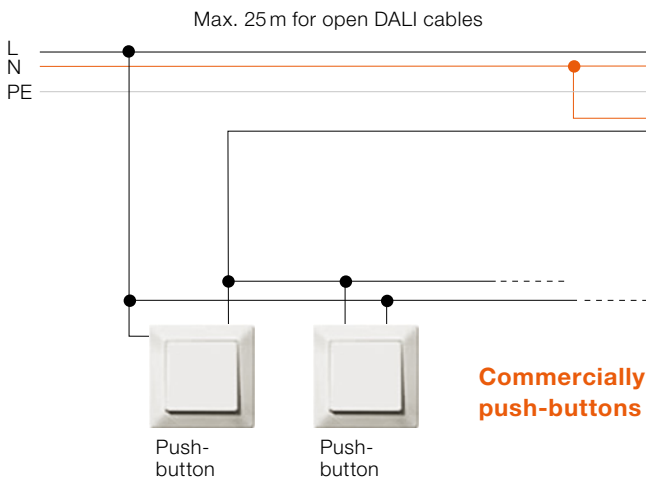

DALI driver  
Dimmable 1...100 %

The total length of all wire connections must not exceed 25 m. For cable lengths of more than 25 m, please use a DALI repeater.

**Touch DIM® installations with more than 25 m cable length with DALI repeater**

For reliable synchronous dimming in Touch DIM® operation even with an open DALI wire length of more than 25 m, OSRAM recommends the use of a DALI repeater. With a DALI repeater, reliable synchronous dimming is even possible for larger distances and a large number of DALI drivers. On the output side of the DALI repeater, DALI commands

are sent to the individual DALI drivers. Due to the fact that these DALI commands go to all connected DALI drivers, all DALI drivers behave the same.

OSRAM offers 2 types of DALI repeaters:

- DALI REPEATER LI – version for luminaire integration
- DALI REPEATER SO – snap-on version with stand-by switch-off possibility

**DALI REPEATER LI for luminaire integration**

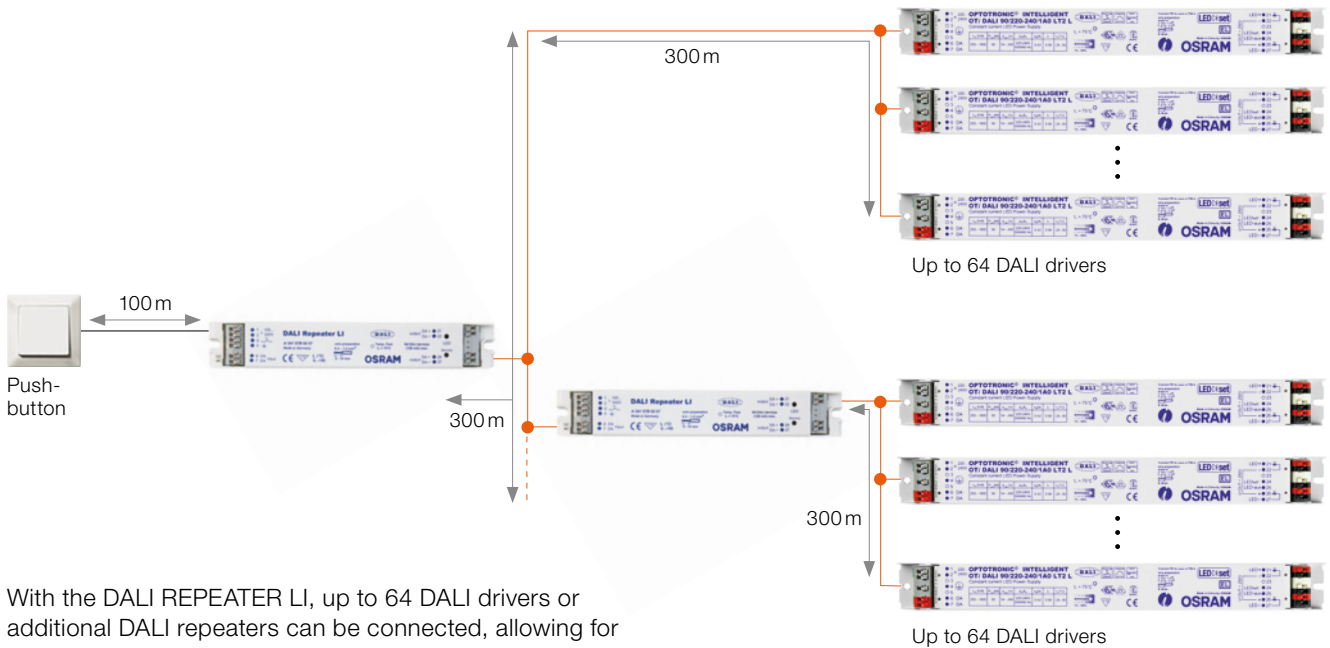

With the DALI REPEATER LI, up to 64 DALI drivers or additional DALI repeaters can be connected, allowing for larger DALI installations. All DALI drivers behave the same. Several push-buttons can be connected in parallel on the input side. The maximum permitted cable length is 100m.

**DALI REPEATER SO with stand-by switch-off possibility**

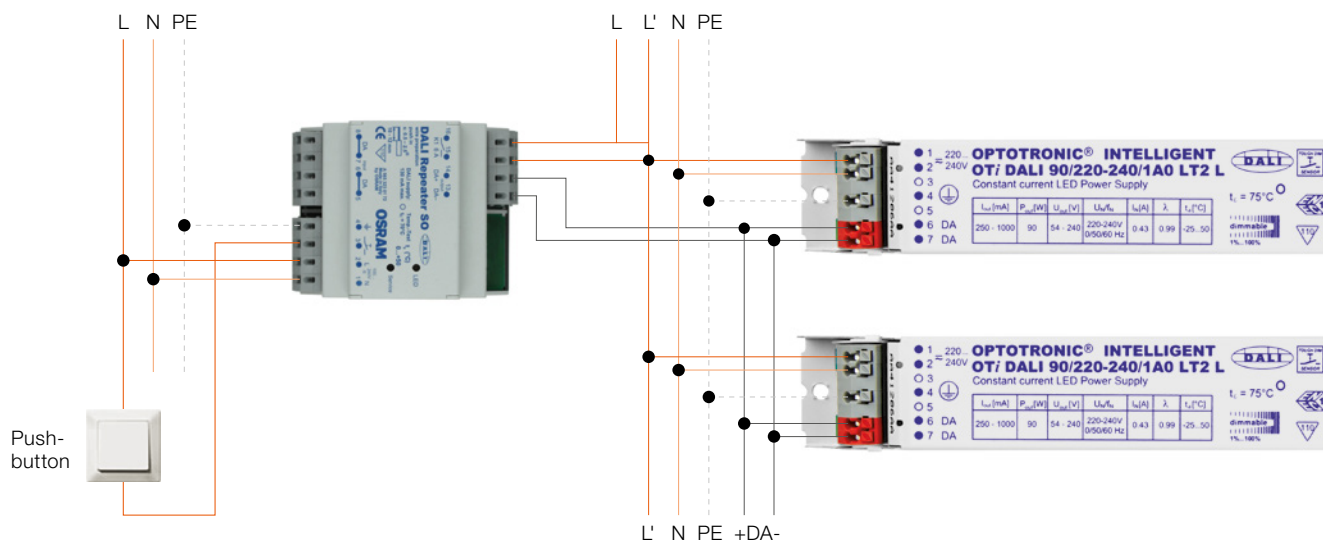

→ The stand-by consumption of the connected luminaires is automatically switched off



The benefit of the snap-on version DALI REPEATER SO is the possibility to switch off the stand-by losses in DALI installations with only a few burning hours and long stand-by times. Especially in larger DALI installations, this has a positive impact on the consumed energy in kWh.

**Touch DIM® Sensor – effective daylight and presence detection**



The optional Touch DIM® Sensor enhances the Touch DIM® function with daylight harvesting and presence detection, which is fully customizable by the user.

Daylight harvesting: The user can simply set the desired lighting level with a push-button. The more natural light is available, the less artificial light will be added.

**Touch DIM® Sensor operation**

- Adjust lighting level: Long press when light is on
- Set lighting level: Double-press when light is on at desired level

Presence detection: In order to improve energy saving, the light is switched off, if nobody is present, after an adjustable delay time (using Tuner4TRONIC® or DALI Wizard).

**Operating mode with Touch DIM® Sensor**

Touch DIM® Sensor operation is a special “control” mode (not mode 1 or 2 of the pure Touch DIM® operation without sensor).

**Note:** For detailed instructions, please refer to the [Touch DIM® Sensor user manual](#).

With 1 Touch DIM® Sensor, up to 4 DALI drivers can be controlled.

**Daylight- and presence-dependent control with Touch DIM® Sensor**

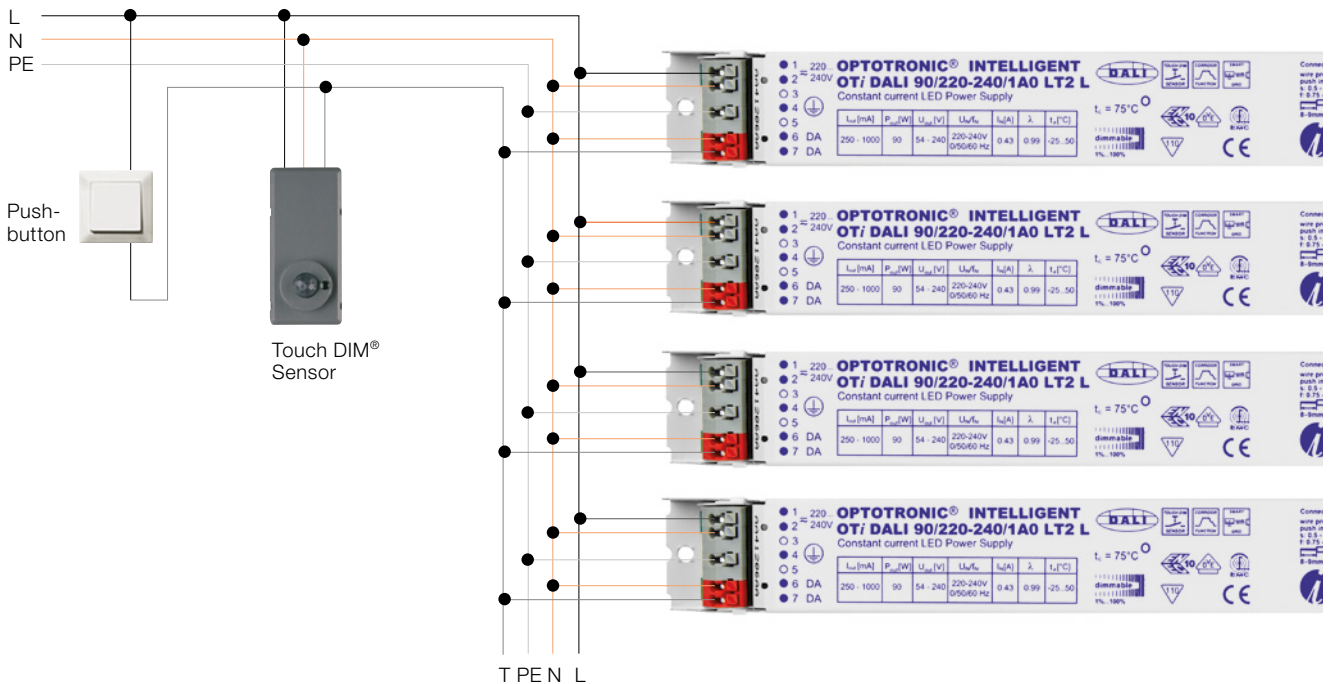

### Behavior of DALI LED drivers after a mains voltage interruption in Touch DIM® Sensor mode

In any case, the light switches on reliably. If no motion is detected, the light switches off after 15 minutes.

Especially after a mains voltage interruption, there are differences in Touch DIM® Sensor operation of QT i DALI GII ECGs and OT i DALI drivers:

- OPTOTRONIC® Intelligent (OT i) DALI drivers always switch on the connected LED load and start the control mode again.
- QUICKTRONIC® Intelligent (QT i) DALI GII ECGs, however, continue with the last DALI value before the mains voltage interruption (if mains output level = 255).

This means in consequence for mains output level = 255: switch-on of OT i DALI luminaires after a mains voltage interruption and no switch-on of QT i DALI GII luminaires.

Touch DIM® Sensor settings including controls and operating modes can be easily customized with the software DALI Wizard or Tuner4TRONIC®.

### Corridor function – easy time-based lighting profiles for up to 20 DALI drivers



The corridor functionality offers the possibility to light up rooms automatically using standard push-buttons or presence detection sensors (PIR). It is possible to define a time-based lighting profile with up to three different levels, which are fully customizable with the software DALI Wizard or Tuner4TRONIC®.

#### Corridor function phasing (general and factory setting)

General curve:

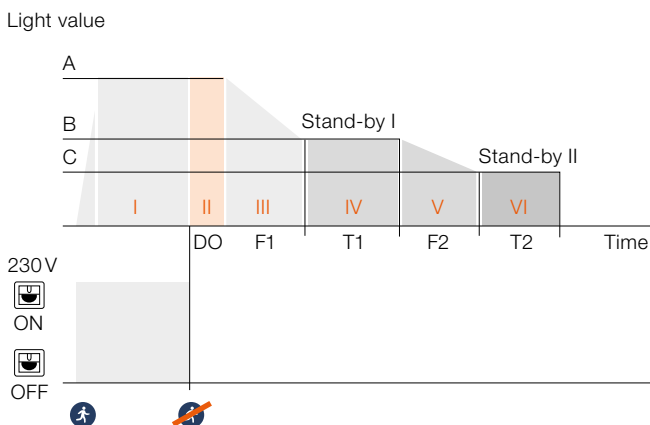

Three dimming ranges (1...100 %), free parameterization of time (I...VI) using DALI magic.

Factory setting:

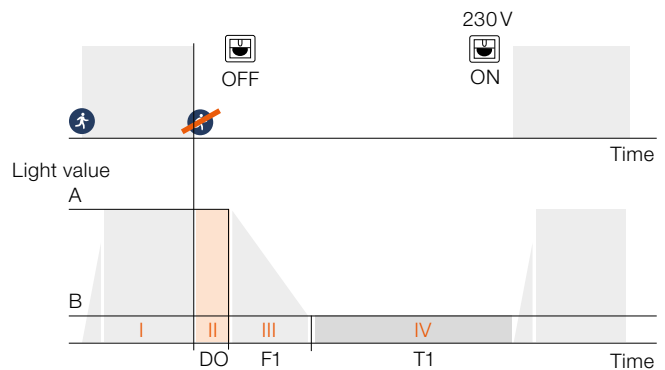

#### Factory-set parameters:

A: 100 %, DO: 120 s, F1: 32 s  
B: 10 %, T1: unlimited

It is possible to connect the DALI LED drivers directly to commercially available motion sensors. The corridor function is triggered by a switching signal, i.e. the voltage of the supply line (220–240V, 50/60Hz) is switched to the DALI control line inputs (DA, DA; see diagram below). A preset “out-of-the-box” control profile is activated upon triggering. This can be individually adjusted via DALI Wizard or Tuner4TRONIC® and DALI magic. Three light levels and six time and fade settings are available for this purpose.

**Advantage:** New applications (stairwells, corridors, large storage facilities etc.) can be developed with the possibility to save energy and achieve high energy efficiency.

**Wiring diagram for corridor function (up to 20 DALI drivers permitted)**

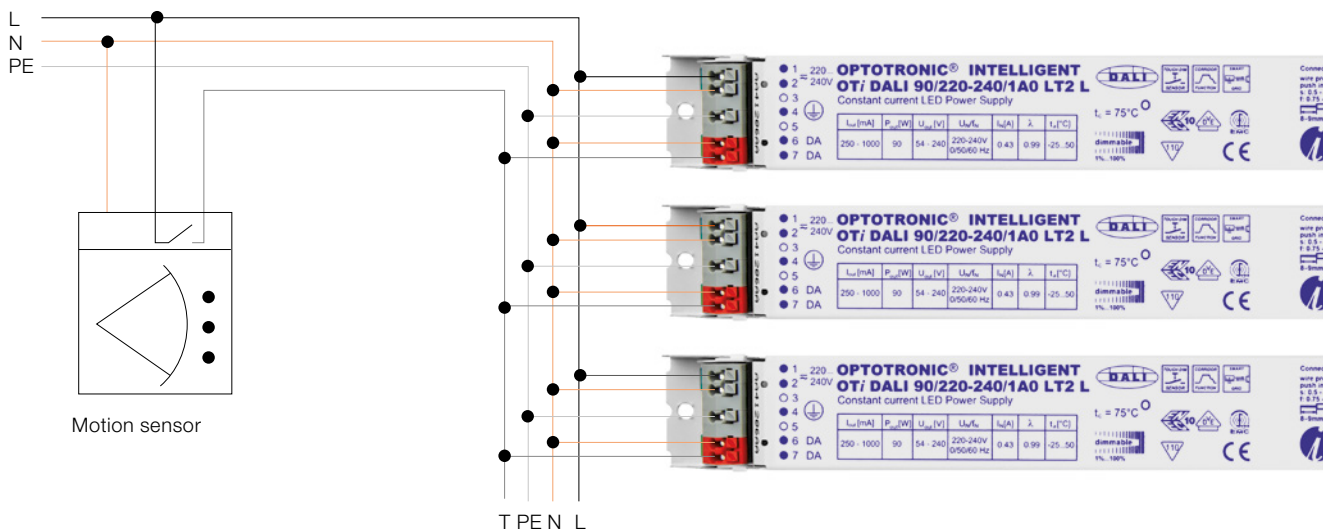

**Activation of the corridor function**

The corridor function is activated when the supply voltage (220–240V) is permanently applied to the DALI input of the driver for at least 120 seconds (50 Hz) or when the motion sensor detects movement for at least 120 seconds. For DALI LED drivers (version DALI 2), the corridor function has to be activated by the Tuner4TRONIC® software.

**Switching from the corridor function to the Touch DIM® function and vice versa**

It is possible to switch from the corridor function to the Touch DIM® function by briefly pressing a push-button 5 times (at the DALI input, 220–240V) within 3 seconds. For a reliable exit of the corridor function, it is a must to have a minimum time of 0.5s between the 5 individual push-button presses. The same recommendation applies to the Touch DIM® RC (radio-controlled) solution. For DALI LED drivers (version DALI 2), the Touch DIM® function is not available when the corridor function is activated.

**Synchronization (Touch DIM® and Touch DIM® Sensor operation)**

If a large number of DALI drivers with Touch DIM® are operated in a system, there is a chance that a DALI driver will operate out of sync with the others (= different dimming level setting or different switching state).

Synchronization can be restored as follows:

- Step 1: Long** press of the push-button (> 0.5 s) → All the LEDs are switched on
- Step 2: Short** press of the push-button (< 0.5 s) → All the LEDs are switched off
- Step 3: Long** press of the push-button (> 0.5 s) → All the LEDs are switched on at minimum dimmer setting and fade up

After the first three steps – **long-short-long** – all drivers are synchronized.

**Note:** Touch DIM® is designed for manual control. It is not suitable for a connection to a PLC (Programmable Logic Control; SPS) or BMS control system.

# Technical application guide

## OPTOTRONIC® LED drivers for indoor application

### 5 Combination of LED module and LED driver in constant-current systems

### Matching of LED module and LED driver in constant-current systems

Matching the driver and the LED module is associated with a number of possible errors. Therefore, OSRAM offers not only components but also released systems of module/driver combinations, which solve all the issues described on the following pages. You can learn more about these systems in the OSRAM Matchmaker.

#### Safety first

Drivers providing an internal SELV isolation barrier are the most frequently used drivers. They allow for a simpler construction of the luminaire. Drivers without mains isolation, however, are gaining in market share because they excel in costs, efficacy and size. When a non-isolated driver is used, the LED chain shows a high voltage against earth. Consequently, a safety isolation has to be established between the LEDs and touchable parts of the luminaire. In order to support realistic constructions of the luminaire, safety issues already have to be considered during the

construction of the module. This requires detailed knowledge of safety standards, drivers and LEDs.

#### Immunity/surge

Transient voltages from the mains can travel through the driver to the module. Common mode transients can cause high stress to the isolation between LED and PE. If a driver offers an earth terminal, it is always advisable to implement the earth connection. The earth connection of the driver greatly reduces the common mode transients that are transferred to the module. This recommendation is valid also for luminaire constructions that would meet safety regulations even without connecting the driver to earth.

#### Operating points

The operating point of the LED module must be within the operating range of the LED driver. Due to natural parameter variations of modules and drivers, multiple pitfalls have to be avoided to meet this simple requirement.

### Operating window of an LED driver

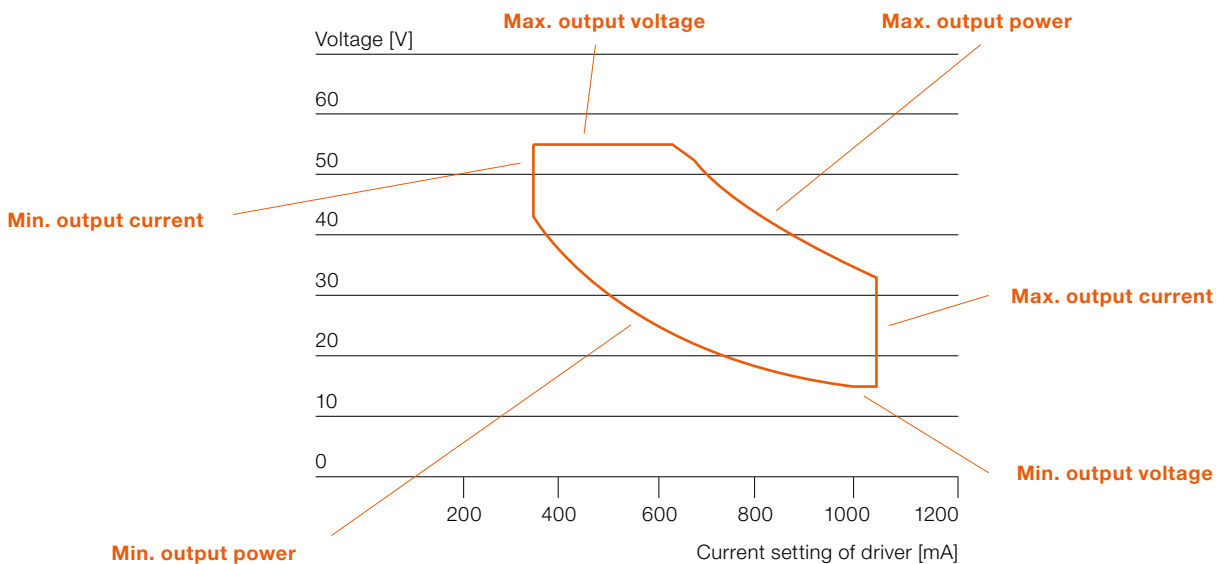

**Note:** In case a module exceeds the limits of the LED driver operating range, shutdown or blinking may occur with some drivers.

#### Voltage-current characteristic of a single LED

The characteristic of the single LED can be visualized in a V-I graph.

- $V_F$  depends on binning
- $V_F$  depends on temperature
- $V_F$  depends on current
- $V_F$  depends on aging

Already in pure DC operation, the prediction of the operating point is not a point but a line.

#### Voltage-current characteristic of LEDs

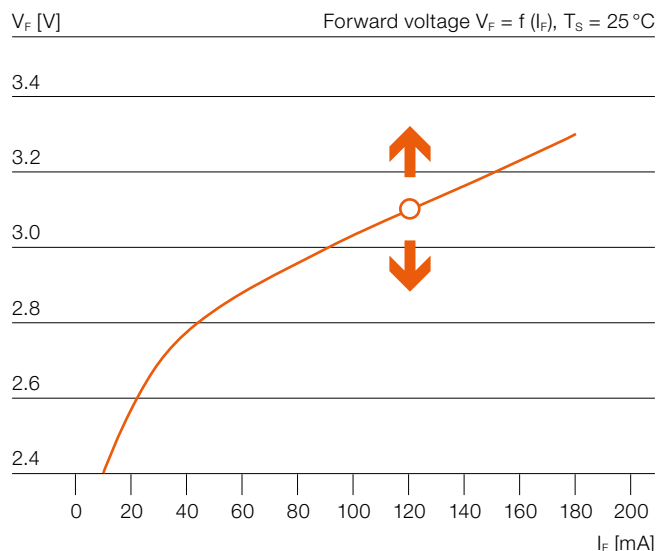

### Module meets LED driver

By drawing the parameters of the LED module and the LED driver in the same V-I graph, the situation can be visualized.

#### V-I graph

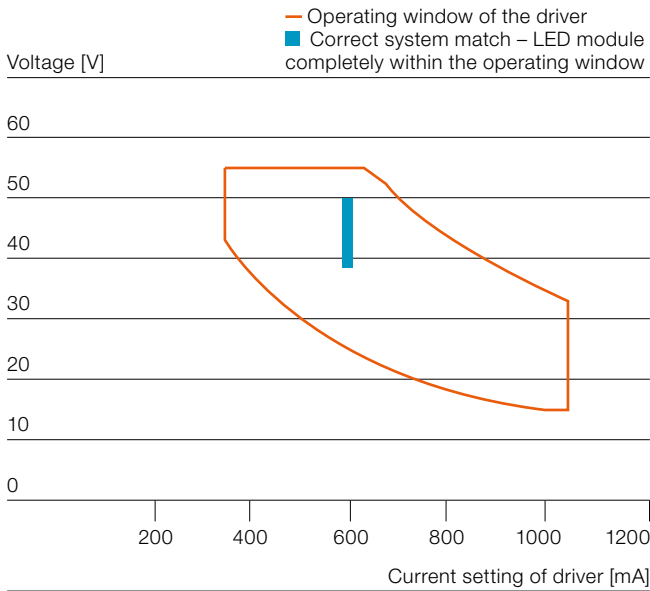

The above V-I graph shows a correct system match. The predicted line of the operating points is completely within the operating range of the LED driver.

### Influence of the LED module on $V_f$

The forward voltage can differ from the rated values and has the potential to cause an undesired shutdown or blinking.

It is influenced by the following effects.

#### Forward voltage influencing factors

- LED driver does not deliver pure DC (→ ripple current)
- LED driver output current deviates from selected value
- Voltage binning of module
- Aging of module
- Temperature of module

In addition to the correct selection of the forward voltage, it is important to avoid an overload of the LED module. Check the module current load by taking into account the current accuracy of the LED driver and system ripple current.

### Additional requirements on driver/module matching for dimming

The real number of supported LEDs needs to be checked according to the minimum and maximum forward voltage in the worst case conditions. The respective forward voltage must not fall below/exceed the minimum/maximum output voltage of the used LED driver. The forward voltage of the connected LED module in dimming condition is lower than the forward voltage in nominal condition but still has to be above the minimum output voltage of the LED driver.

### Influence of dimming and temperature on the forward voltage

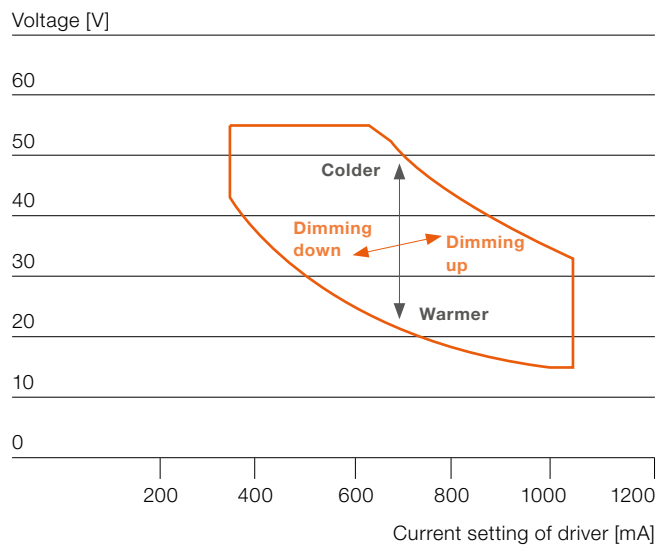

### Influence of binning, aging and driver tolerances on the forward voltage

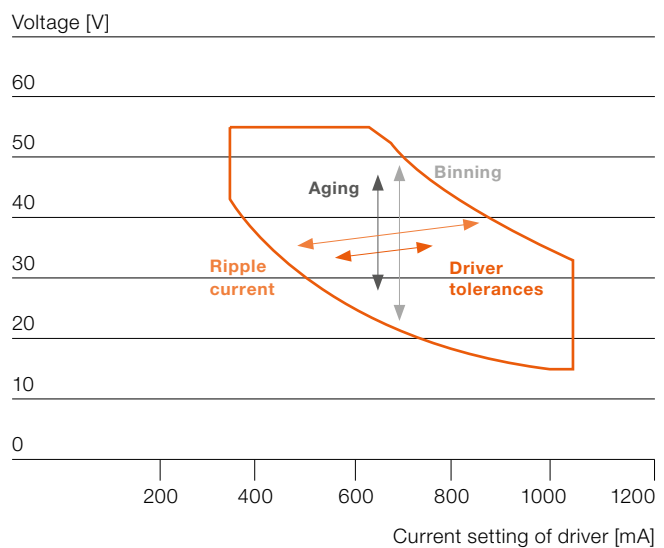

# Technical application guide OPTOTRONIC® LED drivers for indoor application

## 6 The OSRAM Matchmaker – LED modules and system compatibilities

### General

In order to support customers in finding the suitable configuration and type of LED driver for specific LED modules, OSRAM has implemented an Excel-based calculation tool, which is available in the OEM Download Center at [www.osram.com/oem-download](http://www.osram.com/oem-download).

If you download the tool and open the Excel file, the following menu is shown:

#### OSRAM MATCHMAKER v1.07

Data as of 03.07.2015 09:29:00



**INPUT DATA**

**Device selection**  
Module/driver combination: Select Module & Driver

**Module temperature**  
at T\_C point: 65 °C

**Target setting (define one)**  
target current: 960 mA  
target flux: 4500 lm

**System setup**  
no parallel modules: 1  
no modules in series: 1

**OUTPUT DATA** PL-CORE-Z4-5000-830

	OTe 50/220-240/1A0 CS DTC					FLEX DRIVER	
	I1	I2	I3	I4	I5	target current	target flux
ECG current (mA)	800	925	1050	-	-	960	960
temperature (°C)	-	65	-	-	-	65	65
Modules flux (lm)	-	4362	-	-	-	4500	4500
Modules voltage (V)	-	43,2	-	-	-	43,4	43,4
Modules power (W)	-	40,0	-	-	-	41,7	41,7
Modules efficacy (lm/W)	-	103	-	-	-	108	108
ECG efficiency full load (%)	-	87%	-	-	-	na	na
System power (W)	-	46,0	-	-	-	na	na
System efficacy (lm/W)	-	95	-	-	-	na	na

**DIAGRAMS**

DISCLAIMER: Please note that the tool gives expected/typical values but not specification values and is based on measurements and approximations. The operating data stated here exceeds the specified operating ranges, e.g. goes beyond the maximum specifications in some cases. Please always check the datasheet as the only binding data source and specification. All information in this calculation tool has been prepared with great care. OSRAM GmbH, however, does not accept liability for possible errors, changes and/or omissions and is not responsible for the correctness and completeness of the information contained in this calculation tool and OSRAM GmbH cannot be made liable for any damage that occurs in connection with the use of and/or reliance on the content of this calculation tool. This calculation tool is for information purposes only and aims to support you in tackling the challenges and taking full advantage of all opportunities the technology has to offer. Please note that this calculation tool is based on own measurements, tests, specific parameters and assumptions. Individual applications may not be covered and need different handling. Responsibility and testing obligations remain with the luminaire manufacturer/CIEM/application planner. The information contained in this calculation tool reflects the current state of knowledge on the date of issue.

The tool consists of three parts:

- Input data
- Output data
- Diagrams

In the section “INPUT DATA”, the user can select a module/driver combination and set all relevant module driving parameters: temperature, current and luminous flux. The user can also find the configuration of the selected system (system setup), i.e. the wiring of the selected module/driver combination, at the bottom of this section.

**INPUT DATA**

**Device selection**  
Module/driver combination: Select Module & Driver

**Module temperature**  
at T\_C point: 65 °C

**Target setting (define one)**  
target current: 960 mA  
target flux: 4500 lm

**System setup**  
no parallel modules: 1  
no modules in series: 1



In the second section, all available output data are displayed in a table:

OUTPUT DATA		PL-CORE-Z4-5000-830					FLEX DRIVER	
	OTe 50/220-240/1A0 CS DTC					target current	target flux	
	I1	I2	I3	I4	I5			
ECG current (mA)	800	925	1050	-	-	960	960	
temperature (°C)	-	65	-	-	-	65	65	
Modules flux (lm)	-	4362	-	-	-	4500	4500	
Modules voltage (V)	-	43,2	-	-	-	43,4	43,4	
Modules power (W)	-	40,0	-	-	-	41,7	41,7	
Modules efficacy (lm/W)	-	109	-	-	-	108	108	
ECG efficiency full load (%)	-	87%	-	-	-	na	na	
System power (W)	-	46,0	-	-	-	na	na	
System efficacy (lm/W)	-	95	-	-	-	na	na	

The two columns with the headline “FLEX DRIVER” provide specific target values based on the entered input data. “FLEX DRIVER”, in this case, means that it is possible that the driving parameters fit the selected LED module but not necessarily the selected LED driver. The possible parameters of the selected LED driver are shown in the middle of the table.

The section “DIAGRAMS” gives an overview of possible results for a wide range of parameters:

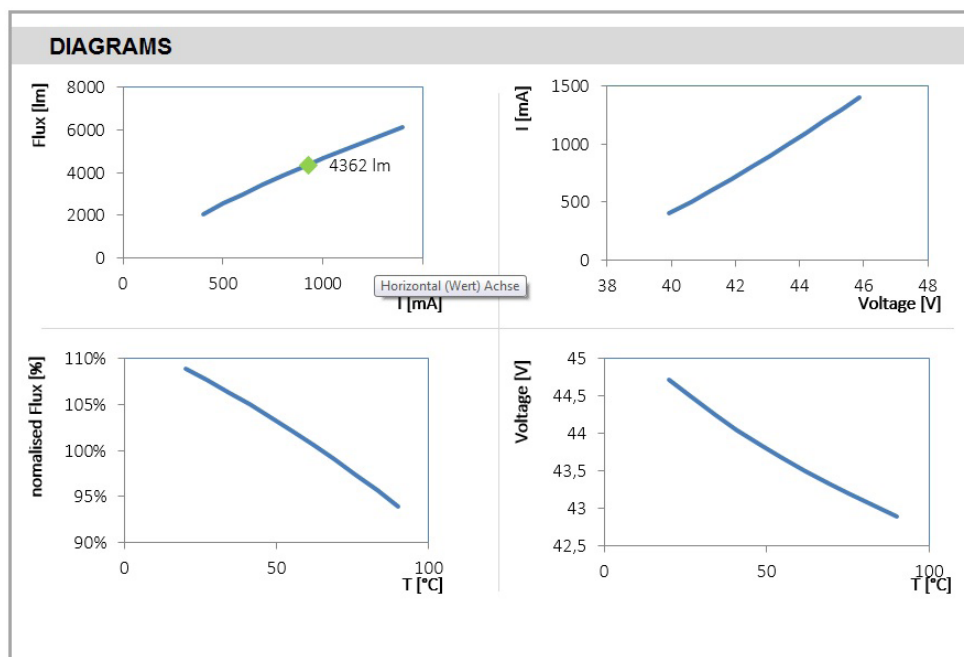

**Use**

The user can easily go through the tool step by step. As the first step, the user needs to select the system he wants to have a look at:

INPUT DATA		OUTPUT DATA <span style="float: right;">PL-CORE-Z4-5000-830</span>							
<b>Device selection</b>									
Module/driver combination	Select Module & Driver	<b>OTe 50/220-240/1A0 CS DTC</b>						<b>FLEX DRIVER</b>	
		I1	I2	I3	I4	I5	target current	target flux	
<b>Module temperature</b>									
at T_C point	65 °C								
<b>Target setting (define one)</b>									
target current	960 mA								
target flux	4500 lm								
<b>System setup</b>									
no parallel modules	1								
no modules in series	1								
ECG current (mA)		800	925	1050	-	-	960	960	
temperature (°C)		-	65	-	-	-	65	65	
Modules flux (lm)		-	4362	-	-	-	4500	4500	
Modules voltage (V)		-	43,2	-	-	-	43,4	43,4	
Modules power (W)		-	40,0	-	-	-	41,7	41,7	
Modules efficacy (lm/W)		-	109	-	-	-	108	108	
ECG efficiency full load (%)		-	87%	-	-	-	na	na	
System power (W)		-	46,0	-	-	-	na	na	
System efficacy (lm/W)		-	95	-	-	-	na	na	

By clicking on the button “Select Module & Driver”, the dialog box “System Selector” opens and the user can select the LED module and suitable LED drivers:

**Please select system: module & driver**

COIN 111 COIN 50 PrevaLED CORE Z3 <b>PrevaLED CORE Z4</b> PrevaLED Cube PrevaLED Cube G2 PrevaLED Linear Slim 2 PrevaLED Linear Slim Gen1 PreveLED Linear Value PreveLED Linear Value 2	2000 3000 <b>5000</b>	CRI80 - 3000K CRI80 - 3500K CRI80 - 4000K CRI90 - 3000K	1 (1s1p)	OTe 50/220-240/1A0 CS DTC
--	-----------------------------	--	----------	---------------------------

Select System

Cancel

The selected system is included into the Excel sheet starting with the nominal values:

INPUT DATA		OUTPUT DATA <b>PL-CORE-Z4-5000-830</b>							
<b>Device selection</b>		<b>OTe 50/220-240/1A0 CS DTC</b>					<b>FLEX DRIVER</b>		
Module/driver combination	Select Module & Driver	I1	I2	I3	I4	I5	target current	target flux	
<b>Module temperature</b>		ECG current (mA)							
at T <sub>C</sub> point	65 °C	800	925	1050	-	-	960	960	
<b>Target setting (define one)</b>		temperature (°C)							
target current	960 mA	Modules flux (lm)							
target flux	4500 lm	-	4362	-	4500				4500
<b>System setup</b>		Modules voltage (V)							
no parallel modules	1	-	43,2	-	43,4				43,4
no modules in series	1	Modules power (W)							
		-	40,0	-	41,7				41,7
		Modules efficacy (lm/W)							
		-	109	-	108				108
		ECG efficiency full load (%)							
		-	87%	-	na				na
		System power (W)							
		-	46,0	-	na				na
		System efficacy (lm/W)							
		-	95	-	na				na

Now, the user can adapt the three parameters: T<sub>c</sub> temperature, driving current and needed flux for the application.

The user can also choose a higher current than the nominal one (“overdriving”):

INPUT DATA		OUTPUT DATA <b>PL-CORE-Z4-5000-830</b>							
<b>Device selection</b>		<b>OTe 50/220-240/1A0 CS DTC</b>					<b>FLEX DRIVER</b>		
Module/driver combination	Select Module & Driver	I1	I2	I3	I4	I5	target current	target flux	
<b>Module temperature</b>		ECG current (mA)							
at T <sub>C</sub> point	65 °C	800	925	1050	-	-	1200	960	
<b>Target setting (define one)</b>		temperature (°C)							
target current	1200 mA	Modules flux (lm)							
target flux	4500 lm	-	4362	-	5398				4500
<b>System setup</b>		Modules voltage (V)							
no parallel modules	1	-	43,2	-	44,8				43,4
no modules in series	1	Modules power (W)							
		-	40,0	-	53,7				41,7
		Modules efficacy (lm/W)							
		-	109	-	100				108
		ECG efficiency full load (%)							
		-	87%	-	na				na
		System power (W)							
		-	46,0	-	na				na
		System efficacy (lm/W)							
		-	95	-	na				na

This, of course, will result in a higher luminous flux.  
 It is also possible to select a lower driving current (“underdriving”):

INPUT DATA		OUTPUT DATA <span style="float: right;">PL-CORE-Z4-5000-830</span>						
<b>Device selection</b> Module/driver combination	Select Module & Driver	<b>OTe 50/220-240/1A0 CS DTC</b>					<b>FLEX DRIVER</b>	
<b>Module temperature</b> at T_C point	65 °C	I1	I2	I3	I4	I5	target current	target flux
<b>Target setting (define one)</b> target current	400 mA	800	925	1050	-	-	400	960
target flux	4500 lm	-	65	-	-	-	65	65
<b>System setup</b> no parallel modules	1	Modules flux (lm)	-	4362	-	-	2073	4500
no modules in series	1	Modules voltage (V)	-	43,2	-	-	39,9	43,4
		Modules power (W)	-	40,0	-	-	16,0	41,7
		Modules efficacy (lm/W)	-	109	-	-	130	108
		ECG efficiency full load (%)	-	87%	-	-	na	na
		System power (W)	-	46,0	-	-	na	na
		System efficacy (lm/W)	-	95	-	-	na	na

If the user selects a driving current that is not allowed for the selected system, the tool gives a related message:

INPUT DATA		OUTPUT DATA <span style="float: right;">PL-CORE-Z4-5000-830</span>						
<b>Device selection</b> Module/driver combination	Select Module & Driver	<b>OTe 50/220-240/1A0 CS DTC</b>					<b>FLEX DRIVER</b>	
<b>Module temperature</b> at T_C point	65 °C	I1	I2	I3	I4	I5	target current	target flux
<b>Target setting (define one)</b> target current	3000 mA	800	925	1050	-	-	-	960
target flux	4500 lm	-	65	-	-	-	-	65
<b>System setup</b> no parallel modules	1	Modules flux (lm)	-	4362	-	-	-	4500
no modules in series	1	Modules voltage (V)	-	43,2	-	-	-	43,4
		Modules power (W)	-	40,0	-	-	-	41,7
		Modules efficacy (lm/W)	-	109	-	-	-	108
		ECG efficiency full load (%)	-	87%	-	-	-	na
		System power (W)	-	46,0	-	-	-	na
		System efficacy (lm/W)	-	95	-	-	-	na

Current out of spec

If the user adapts the  $T_c$  temperature, all related output data change accordingly:

INPUT DATA		OUTPUT DATA <b>PL-CORE-Z4-5000-830</b>							
<b>Device selection</b> Module/driver combination		<b>OTe 50/220-240/1A0 CS DTC</b>					<b>FLEX DRIVER</b>		
Module/driver combination		I1	I2	I3	I4	I5	target current	target flux	
<b>Module temperature</b> at $T_c$ point		ECG current (mA)	800	925	1050	-	-	960	1003
at $T_c$ point		temperature (°C)	-	80	-	-	-	80	80
<b>Target setting (define one)</b>		Modules flux (lm)	-	4209	-	-	-	4340	4500
target current		Modules voltage (V)	-	42,9	-	-	-	43,1	43,3
target flux		Modules power (W)	-	39,7	-	-	-	41,4	43,5
<b>System setup</b>		Modules efficacy (lm/W)	-	106	-	-	-	105	103
no parallel modules		ECG efficiency full load (%)	-	87%	-	-	-	na	na
no modules in series		System power (W)	-	45,6	-	-	-	na	na
		System efficacy (lm/W)	-	92	-	-	-	na	na

If the user knows the exact luminous flux of his application, he can enter this value in the section "INPUT DATA":

INPUT DATA		OUTPUT DATA <b>PL-CORE-Z4-5000-830</b>							
<b>Device selection</b> Module/driver combination		<b>OTe 50/220-240/1A0 CS DTC</b>					<b>FLEX DRIVER</b>		
Module/driver combination		I1	I2	I3	I4	I5	target current	target flux	
<b>Module temperature</b> at $T_c$ point		ECG current (mA)	800	925	1050	-	-	960	501
at $T_c$ point		temperature (°C)	-	80	-	-	-	80	80
<b>Target setting (define one)</b>		Modules flux (lm)	-	4209	-	-	-	4340	2465
target current		Modules voltage (V)	-	42,9	-	-	-	43,1	40,3
target flux		Modules power (W)	-	39,7	-	-	-	41,4	20,2
<b>System setup</b>		Modules efficacy (lm/W)	-	106	-	-	-	105	122
no parallel modules		ECG efficiency full load (%)	-	87%	-	-	-	na	na
no modules in series		System power (W)	-	45,6	-	-	-	na	na
		System efficacy (lm/W)	-	92	-	-	-	na	na

For spotlighting and downlighting modules, only one-to-one combinations (LED module + LED driver) are possible at the moment. For linear applications, the wiring configuration of the selected system can also be defined in the “System Selector” of the tool:

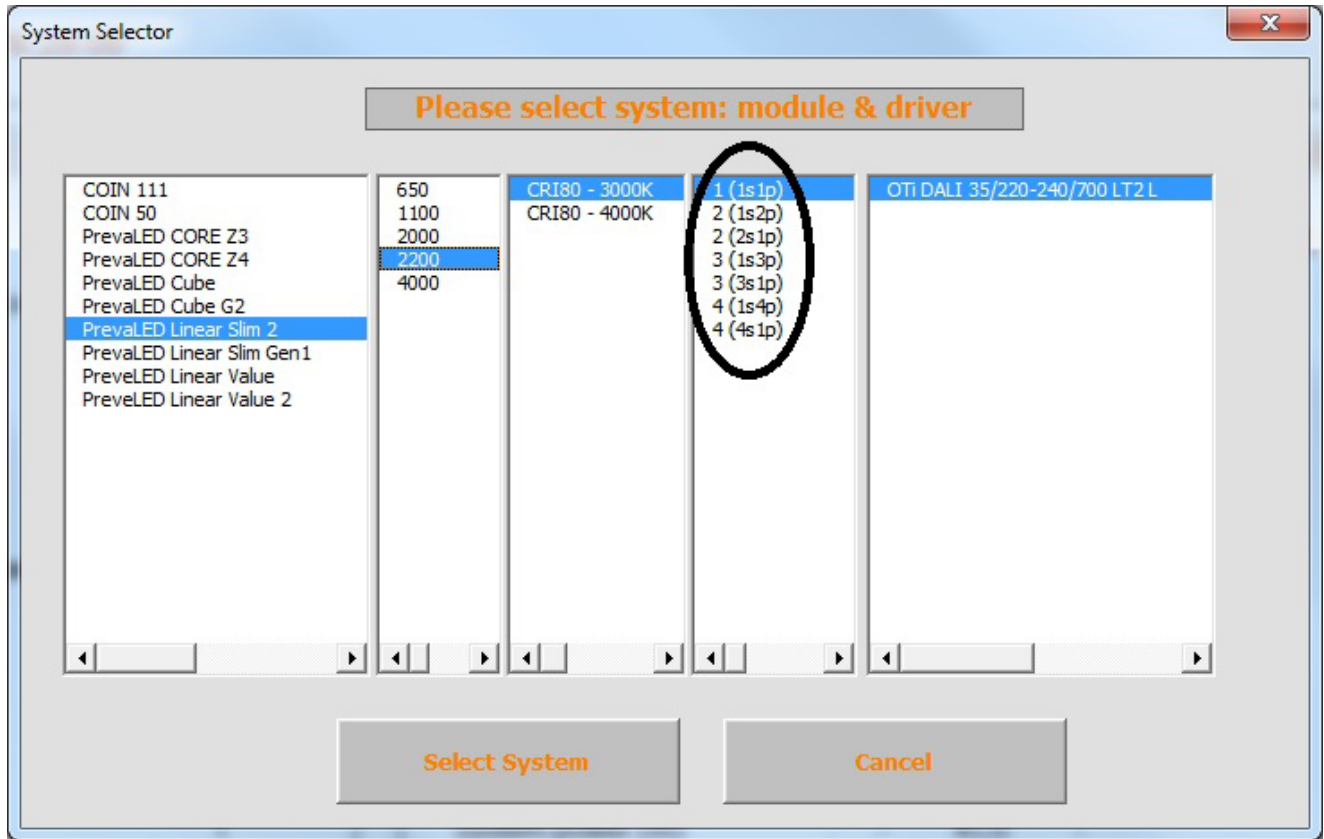

In the fourth column of the “System Selector”, the user can see how many modules can be operated on one driver and how the modules have to be connected: Xs = X in series connection and Yp = Y in parallel connection.



The user's selection is also displayed in the section "INPUT DATA":

**INPUT DATA**

**Device selection**  
Module/driver combination Select Module & Driver

**Module temperature**  
at T\_C point 65 °C

**Target setting (define one)**  
target current 350 mA  
target flux 6150 lm

**System setup**

no parallel modules	1
no modules in series	3

**OUTPUT DATA** **PLSZ2-LIN-2200-830-560-DC**

	OTI 60/220-240/550 D LT2 L					FLEX DRIVER	
	ECG min	Sys min	Sys nom	Sys max	ECG max	target current	target flux
ECG current (mA)	120	350	350	350	550	350	350
temperature (°C)	-	65	65	65	-	65	65
Modules flux (lm)	-	6150	6150	6150	-	6150	6150
Modules voltage (V)	-	125,1	125,1	125,1	-	125,1	125,1
Modules power (W)	-	43,8	43,8	43,8	-	43,8	43,8
Modules efficacy (lm/W)	-	140	140	140	-	140	140
ECG efficiency full load (%)	-	92%	92%	92%	-	92%	92%
System power (W)	-	47,6	47,6	47,6	-	47,6	47,6
System efficacy (lm/W)	-	129	129	129	-	129	129
ECG Rset (kOhm)	41,7	14,3	14,3	14,3	9,1	14,3	14,3

If the user selects an LED driver that allows current setting via the LEDset interface, the required resistor value for the driver is specified in the last row of the section "OUTPUT DATA":

**INPUT DATA**

**Device selection**  
Module/driver combination Select Module & Driver

**Module temperature**  
at T\_C point 65 °C

**Target setting (define one)**  
target current 350 mA  
target flux 6150 lm

**System setup**

no parallel modules	1
no modules in series	3

**OUTPUT DATA** **PLSZ2-LIN-2200-830-560-DC**

	OTI 60/220-240/550 D LT2 L					FLEX DRIVER	
	ECG min	Sys min	Sys nom	Sys max	ECG max	target current	target flux
ECG current (mA)	120	350	350	350	550	350	350
temperature (°C)	-	65	65	65	-	65	65
Modules flux (lm)	-	6150	6150	6150	-	6150	6150
Modules voltage (V)	-	125,1	125,1	125,1	-	125,1	125,1
Modules power (W)	-	43,8	43,8	43,8	-	43,8	43,8
Modules efficacy (lm/W)	-	140	140	140	-	140	140
ECG efficiency full load (%)	-	92%	92%	92%	-	92%	92%
System power (W)	-	47,6	47,6	47,6	-	47,6	47,6
System efficacy (lm/W)	-	129	129	129	-	129	129
ECG Rset (kOhm)	41,7	14,3	14,3	14,3	9,1	14,3	14,3

The OSRAM Matchmaker tool is regularly updated. Please go to the OEM Download Center at [www.osram.com/oem-download](http://www.osram.com/oem-download) to check if you use the latest version.

# Technical application guide OPTOTRONIC® LED drivers for indoor application

## 7 Planning, installation and operation



### System planning

The planning of an LED system (e.g. an LED-based luminaire) must take into consideration the following important factors:

- The selection of suitable LED modules.
- The selection of suitable OPTOTRONIC® (OT) LED drivers that cover all the requested functions (e.g. DALI) and parameters (e.g. SELV).
- The selection of suitable sensors and LMS components.
- The proper wiring of the OT LED drivers and the LED modules and their integration into a luminaire.

The importance of these four factors and their combination for planning a system are first discussed in general in the next sections.

### LED module selection

The very first step in planning an application is the selection of the appropriate LED module(s). For an overview of available LED modules for different applications, please go to [www.osram.com](http://www.osram.com).

OSRAM LED modules can be divided into four categories:

#### 1. Constant-voltage (CV) modules

Constant-voltage modules, even of different types, can be easily connected to constant-voltage OTs without paying attention to current settings (the constant-voltage values of the OT and the LED module, of course, have to be equal, e.g. 24 V). Multiple modules can be connected in parallel to one OT. The most important factor when choosing the LED driver is the maximum wattage needed for all modules connected to the driver.

#### 2. Constant-current (CC) modules with 1-to-1 arrangement of OT and LED module (each LED module has its own OT)

Many OSRAM LED modules are designed to be directly connected to their own OT (e.g. spotlights in retail lighting). The datasheet of the LED module lists different OTs that can be used together with the module. One can choose between different OT variations (e.g. on/off or dimmable) and current settings. The adequate current is often set via LEDset by a resistor directly assembled on the LED module.

#### 3. Constant-current (CC) module arrangements that consist of more than one LED module (multiple LED modules connected to the same OT)

In many applications, multiple LED modules are used with the same driver (e.g. longer chains of linear LED modules in a trunking system). In that case, the modules can be connected to the LED driver in series, in parallel or in a combination of series and parallel. The total power, voltage and current of the LED system have to fit to the chosen LED driver. One can again choose between different OT variations (e.g. on/off or dimmable) and current settings. Additionally, depending on the way the modules are connected, it is possible to select either SELV or non-isolated LED drivers.

### 4. AC LED modules

AC LED modules can be directly connected to mains and do not need an additional OT. They are also available with different configurations (e.g. on/off or dimmable).

### LED driver selection

#### System wattage and forward current in CC systems

At a minimum, the installed OTs must be able to supply the power drawn by the connected modules and any installed controllers. A first orientation in terms of which power level of the driver is required can be derived from the rated power of the connected modules. In order to reach the rated luminous flux, the sum of rated module power shall not exceed the rated power of the driver. Knowing this value and your required feature set, you can go for a first selection of drivers from the OSRAM OT portfolio. In a second step, a detailed analysis of matching LED voltage and LED current with the output parameters of the driver is required.

CC LED systems can be driven at different current levels that result in different luminous flux levels of the system. Datasheets of CC LED modules always mention at least the rated current of the connected module with the rated luminous flux and a maximum current level with the maximum luminous flux level. When choosing the LED driver for a CC system, one has to know the current required to fulfill the lumen output requirements. The OSRAM Matchmaker tool is of great help in finding which driver matches which module/s and in finding the right LED current for a required luminous flux – or vice versa. The Matchmaker tool is available in the OEM Download Center at [www.osram.com/oem-download](http://www.osram.com/oem-download).

#### SELV or non-isolated drivers for linear and area CC systems

For systems of linear and area modules, it is possible, depending on the total voltage of the installed system, to choose between SELV (“Safety Extra Low Voltage”, ≤60V) and non-isolated operation. For SELV operation, the modules are connected in parallel, for non-isolated operation, they are mainly connected in series. Using either a SELV or non-isolated system has a strong impact on the luminaire design. Some of the most relevant facts are summarized in the table below.

### Comparison of SELV and non-isolated LED drivers

	SELV	Non-isolated
<b>Luminaire classes</b>	Classes I, II and III	Only classes I and II
<b>System efficiency</b>	Around 5%, worse than for non-isolated systems	Around 5%, better than for SELV systems
<b>Luminaire design</b>	Easier, e.g. no touch protection of the light source needed	More challenging
<b>Wiring of the modules</b>	Mainly in parallel	Mainly in series

The examples below illustrate the difference in building up a system in SELV or non-isolated operation. PrevaLED® Linear Slim 2 modules with the following nominal parameters are primarily used as light source.

### Typical technical data of PrevaLED® Linear Slim 2 modules (according to datasheet)

Product name	Flux [lm]	CCT [K]	CRI	SDCM	V <sub>F</sub> [V]	I <sub>F</sub> [mA]	P [W]	Efficacy [lm/W]
PLSZ2-LIN-650-840-280-DC	640	4000	> 80	3	32.8	125	4.1	156
PLSZ2-LIN-1100-840-280-DC	1080	4000	> 80	3	41.7	175	7.3	148
PLSZ2-LIN-2000-840-280-DC	1920	4000	> 80	3	40.3	350	14.1	136
PLSZ2-LIN-2200-840-560-DC	2150	4000	> 80	3	41.7	350	14.6	147
PLSZ2-LIN-4000-840-560-DC	3820	4000	> 80	3	40.3	700	28.2	135

Typical values valid for T<sub>c</sub> = 65 °C

#### Example A: Parallel connection

Requirements: 5-ft luminaire in SELV mode, a parallel connection of LED modules, luminous flux of the LED system of 5 500 lm, CCT of 4 000 K, luminaire should be dimmable via DALI.

For these requirements, either five 1-ft modules (see image on page 7.4) or two 2-ft modules and one 1-ft module can be connected in parallel to the LED driver. To achieve a total luminous flux of 5 500 lm, five PLSZ2-LIN-1100-840-280-DC or two PLSZ2-LIN-2200-840-560-DC and one PLSZ2-LIN-1100-840-280-DC can be used.

Both configurations lead to the following electrical parameters:

For 5 x PLSZ2-LIN-1100-840-280-DC:

- I<sub>F total</sub> = 5 x I<sub>F PLSZ2-LIN-1100-840-280-DC</sub> = 5 x 175 mA = **875 mA**
- V<sub>F total</sub> = V<sub>F PLSZ2-LIN-1100-840-280-DC</sub> = **41.7 V**
- P<sub>total</sub> = I<sub>F total</sub> x V<sub>F total</sub> = 875 mA x 41.7 V = **36.5 W**

For 2 x PLSZ2-LIN-2200-840-560-DC and 1 x PLSZ2-LIN-1100-840-280-DC:

- I<sub>F total</sub> = 2 x I<sub>F PLSZ2-LIN-2200-840-560-DC</sub> + 1 x I<sub>F PLSZ2-LIN-1100-840-280-DC</sub>  
= 2 x 350 mA + 1 x 175 mA = **875 mA**
- V<sub>F total</sub> = V<sub>F PLSZ2-LIN-1100-840-280-DC</sub> = V<sub>F PLSZ2-LIN-2200-840-560-DC</sub> = **41.7 V**
- P<sub>total</sub> = I<sub>F total</sub> x V<sub>F total</sub> = 875 mA x 41.7 V = **36.5 W**

It is easy to see that all relevant electrical parameters are the same independent of the chosen configuration.

To use these configurations and ensure a SELV operation, the next step is to choose a suitable LED driver from the OT SELV portfolio. The LED driver has to fulfill the following parameters (if only the nominal parameters are considered and no attention is paid to the aging of the LEDs, temperature dependency etc.):

- I = 875 mA** (either as fixed value or as a set value via LEDset or programming)
- U<sub>max</sub> ≥ 41.7 V** (maximum output voltage has to be higher than V<sub>F total</sub> of the LED system)
- U<sub>max</sub> ≤ 54 V** (maximum output voltage of OT SELV LED driver is not higher than 54 V)
- P<sub>max</sub> ≥ 36.5 W** (maximum output power of the LED driver has to be higher than P<sub>total</sub> of the LED system)

To make things easier, OSRAM provides tables of module/driver configurations in the datasheets of the LED modules. The table on the next page shows a part of the possible SELV configurations for the PrevaLED® Linear Slim 2 modules.

**OTi DALI (window driver – SELV)**

PrevaLED® Linear Slim 2 LED modules are designed to be operated by OTi DALI drivers in parallel connection. Current setting is carried out via the software Tuner4TRONIC® and DALI magic.

**PrevaLED®/driver combinations**

PrevaLED® Linear Slim 2	OTi DALI 50 1A0 27-54 V 0.6-1.4 A 360 x 30 x 21 mm	OTi DALI 80 1A6 27-54 V 0.6-1.55 A 360 x 30 x 21 mm	OTi DALI 80 2A1 27-54 V 1.0-2.1 A 423 x 30 x 21 mm
650lm/125 mA	(4)-10	(4)-12	8-10 (16)
1100lm/175 mA	(3)-6	(3)-8	6-10
2000lm/350 mA	2-3	2-4	3-5
2200lm/350 mA	2-3	2-4	3-5
4000lm/700 mA	1	1-2	2-(3)

The table above shows that 5 x PLSZ2-LIN-1100-840-280-DC (and therefore also 2 x PLSZ2-LIN-2200-840-560-DC & 1 x PLSZ2-LIN-1100-840-280-DC) is possible for both the OTi DALI 50 1A0 and the OTi DALI 80 1A6 LED drivers. The LED driver OTi DALI 80 2A1 has an output current of 1 to 2.1 A and can therefore not be used with a minimum current of 875 mA for the LED modules. The current can be set either by LEDset or fixed current mode via Tuner4TRONIC®.

**5-ft SELV luminaire**



Equipped with: **PrevaLED® Linear Slim 2**  
**“PLVZ2-LIN-1100-840-280-DC”**  
**OTi DALI 50 1A0 27-54 V**

Configuration: **1s5p**

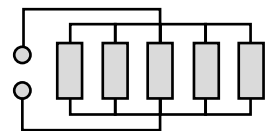

DC current [mA]: 875  
 DC voltage [V]: 41.7  
 Luminous flux [lm]: 5400

**Example B: Series connection**

Requirements: 5-ft luminaire in non-isolated mode, a series connection of LED modules, luminous flux of the LED system of 5 500 lm, CCT of 4 000 K, luminaire should be dimmable via DALI. Same conditions as in example A, only the SELV mode is changed to the non-isolated mode.

**Note:** In the non-isolated mode, it is only possible to use five 1-ft modules connected in series to build up a 5-ft LED system. It is not possible to use two 2-ft modules and one 1-ft module connected in series to the LED driver.

To achieve a total luminous flux of 5 500 lm, PLSZ2-LIN-1100-840-280-DC can be used, connected in series to the LED driver.

This leads to the following electrical parameters:

$$I_{F \text{ total}} = I_{F \text{ PLSZ2-LIN-1100-840-280-DC}} = 175 \text{ mA} = \mathbf{175 \text{ mA}}$$

$$V_{F \text{ total}} = 5 \times V_{F \text{ PLSZ2-LIN-1100-840-280-DC}} = \mathbf{208.5 \text{ V}}$$

$$P_{\text{total}} = I_{F \text{ total}} \times V_{F \text{ total}} = 175 \text{ mA} \times 208.5 \text{ V} = \mathbf{36.5 \text{ W}}$$

Now, as in example A, a suitable LED driver has to be selected, this time from the non-isolated part of the OT portfolio. It has to fulfill the following parameters (if only the nominal parameters are considered and no attention is paid to the aging of the LEDs, temperature dependency etc.):

- I = 175 mA** (either as fixed value or as a set value via LEDset or programming)
- U<sub>max</sub> ≥ 208.5 V** (maximum output voltage has to be higher than V<sub>F total</sub> of the LED system)
- U<sub>max</sub> ≤ 250 V** (maximum allowed voltage for the PrevaLED® Linear Slim 2 family)
- P<sub>max</sub> ≥ 36.5 W** (maximum output power of the LED driver has to be higher than P<sub>total</sub> of the LED system)

The tables shown in example A for the SELV configuration are also provided in the datasheets for the non-isolated case.

**OTi (window driver – non-isolated)**

PrevaLED® Linear Slim 2 LED modules are designed to be operated by OTi and OTi DALI drivers in series or combined series/parallel connection. Current setting is carried out via resistor coding (LEDset) in case of OTi and via the software Tuner4TRONIC® and DALI magic in case of OTi DALI.

Explanation:

- Xs1p: all modules in series connection
- Xs2p/2sYp: parallel connection of X modules in series connection/series connection of Y modules in parallel connection

The table shows that 5 x PLSZ2-LIN-1100-840-280-DC is possible for the OTi DALI 60 550 LED drivers (and the OTi DALI 90 1A0 LED drivers with increased current I<sub>F</sub> ≥ 250 mA). Apart from the DALI functionality, OTi 60 and OTi 90 provide the same range of functions as OTi DALI 60 and OTi DALI 90. If DALI is not required, they are also possible solutions.

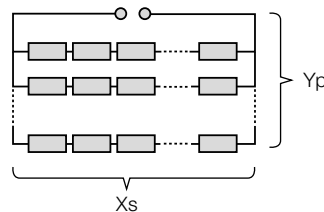

**PrevaLED®/driver combinations**

PrevaLED® Linear Slim 2	OTi 60 550 54–240 V 125–550 mA 280 x 30 x 21 mm	OTi 90 1A0 54–240 V 250–1000 mA 280 x 30 x 21 mm	OTi DALI 60 550 54–240 V 125–550 mA 280 x 30 x 21 mm	OTi DALI 90 1A0 54–240 V 250–1000 mA 280 x 30 x 21 mm
650 lm/125 mA	2–5 (Xs1p/Xs2p)	4–10 (Xs2p/2sYp)	2–5 (Xs1p/Xs2p)	4–10 (Xs2p/2sYp)
1100 lm/175 mA	2–5* (Xs1p/Xs2p)	4–10* (Xs2p/2sYp)	2–5* (Xs1p/Xs2p)	4–10* (Xs2p/2sYp)
2000 lm/350 mA	2–3 (Xs1p)	2–4 (Xs1p)	2–3 (Xs1p)	2–4 (Xs1p)
2200 lm/350 mA	2–3 (Xs1p)	2–4 (Xs1p)	2–3 (Xs1p)	2–4 (Xs1p)
4000 lm/700 mA	–	2–3 (Xs1p)	–	2–3 (Xs1p)

\* For 5 x 1100 lm, please keep the T<sub>c</sub> temperature below 65 °C and observe the maximum current I<sub>F</sub> = 175 mA per module

### 5-ft non-isolated luminaire

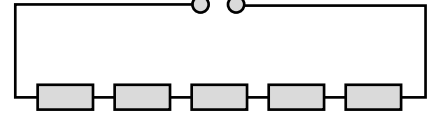
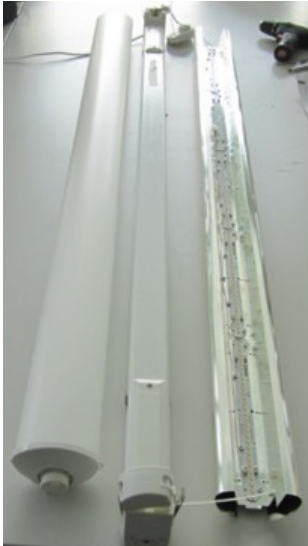

Equipped with: **PrevaLED® Linear Slim 2**  
**“PLSZ2-LIN-1100-840-280”**  
**OTi DALI 60/220-240/550 D LT2 L**

Configuration: **5s1p**

DC current [mA]: 175 (set by LEDset/Tuner4TRONIC®)  
DC voltage [V]: 208.5  
Luminous flux [lm]: 5400

The figure above shows a typical application example for a 1.5-m luminaire with a linear non-isolated driver OTi DALI 60/220-240/550 D LT2. All PrevaLED® Linear Slim 2 PLSZ2-LIN -1100-840-280 modules are connected in series.

**Example C: Series connection by use of terminals**

The figure below shows an application of a floor-standing luminaire with a linear non-isolated driver OTi DALI 90/220-240/1A0 LT2 L. It is an example for a series connection by optimal use of the terminals of the OTi (DALI) non-isolated family. All PrevaLED® Linear Slim 2 PLSZ2-LIN-1100-840-280 modules are connected in series.

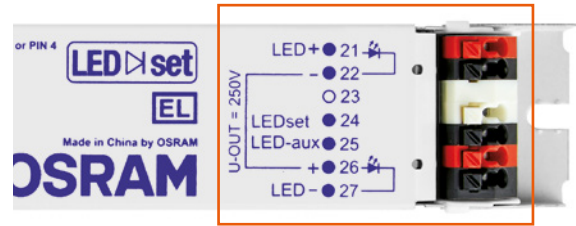

The split of the LED modules does not need to be symmetric as shown below.

**Pinning/connection diagrams: OTi DALI 90/220-240/1A0 LT2 L**

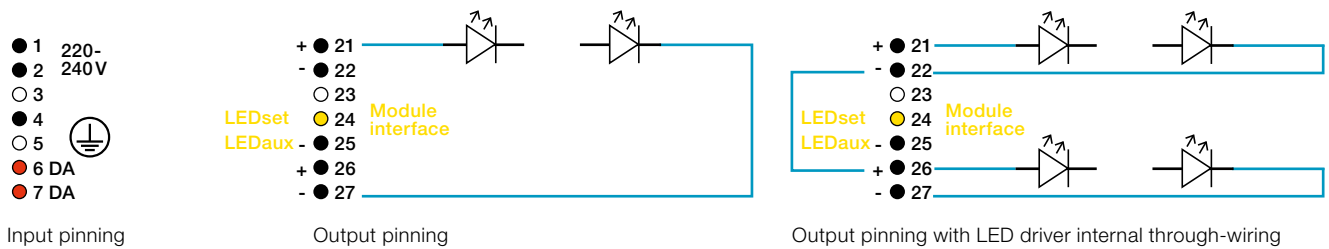

Asymmetric LED module (load) wiring permitted

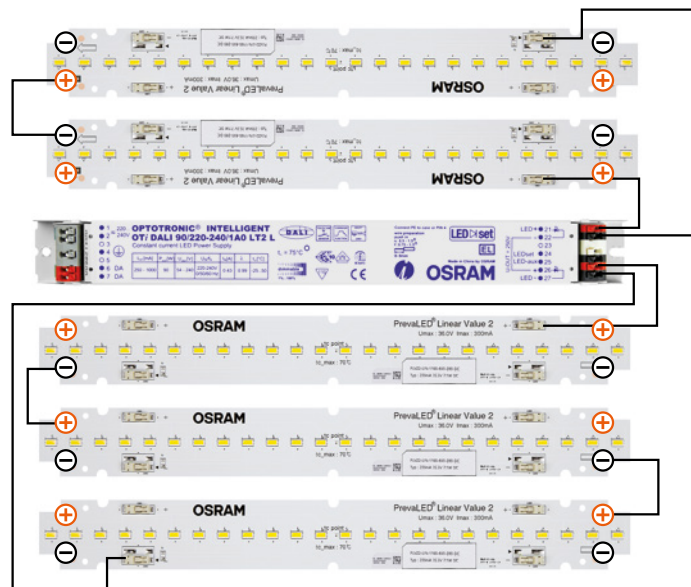

**Example D: Combined series/parallel connection**

Depending on the electrical parameters of the LED module and the selected OT LED driver, different numbers of modules can be connected in series/in parallel to the LED driver.

In the non-isolated case, it is possible to combine parallel and series wiring of LED modules. In a 4-ft luminaire, for example, there are two options to connect the modules:

a) All in series

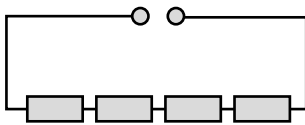

b) Two in series and two in parallel

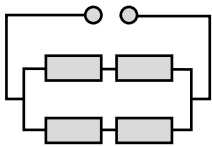

The electrical parameters change with the chosen condition. In case a), the total voltage of the LED system is four times the module voltage and the system current is the same as the module current. In case b), the total voltage of the LED system is two times the module voltage and the system current is also two times the module current. These two different scenarios of wiring can strongly impact the selection of a suitable LED driver.

The XsYp notation used in OSRAM datasheets gives information on how many modules can be connected to the LED driver. X stands for the number of modules connected in series and Y for the number of modules connected in parallel. For cases a) and b) in a 4-ft luminaire, the corresponding XsYp notations are:

a) All in series → 4s1p

b) Two in series and two in parallel → 2s2p

In addition, the datasheets also provide exact wiring diagrams (see figures below).

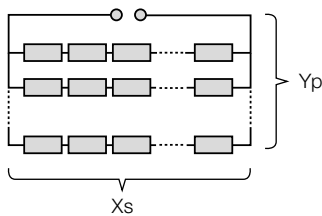
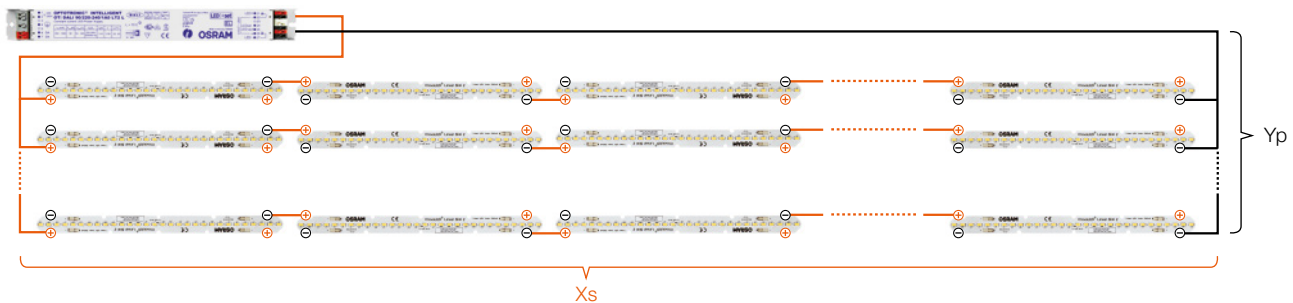

Corresponding circuit diagram

### 4-ft non-isolated luminaire – twin lamp

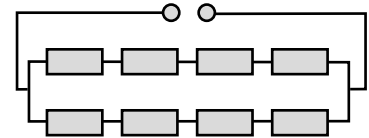
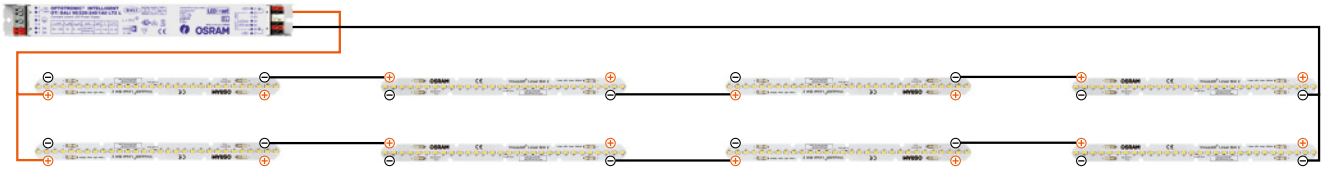

Equipped with: **PrevaLED® Linear Slim 2**  
**“PLSZ2-LIN-650-840-280”**  
**OT FIT 50/220-240/250 D L**

Configuration: **4s2p**

DC current [mA]: 250  
 DC voltage [V]: 132  
 Luminous flux [lm]: 5120

The figure above shows a typical application example for a 1.2-m luminaire with a linear non-isolated driver OT FIT 50/220-240/250 D L. The PrevaLED® Linear Slim 2 modules are connected in combined series/parallel connection (4s2p; 4 modules in series, 2 strings in parallel).



**Light control  
(on/off, different dimming mechanisms)**

The level of light control in an application ranges from no control (i.e. fixed output) to simple control (i.e. brightness) to full RGB or TW control (i.e. multiple independently controlled channels). Besides the level of control, the preferred type of control interface, e.g. 1...10V, DALI or DMX, must also be selected.

Combined with the type of LED modules selected in the first step, these requirements can be used to further search the OPTOTRONIC® portfolio for suitable LED drivers and to look for additional light management systems.

**CV LED drivers**

There are three different categories of OT CV LED drivers:

- Non-dimmable drivers (on/off)
- Drivers with 1...10-V interface
- Drivers with DALI interface

**CC LED drivers**

Dimmable OT CC LED drivers mainly use the DALI interface. There are also some CC LED drivers in the portfolio that use a 1...10-V and phase-cut. OT CC LED drivers are also available as non-dimmable (on/off) versions.

For the DALI interface, in particular, OSRAM offers many light management systems that can be used together with OT DALI LED drivers. The available light management system components range from easy systems that, for example, are used in small offices to professional systems for entire buildings or complexes of buildings.

Additional information on light management systems can, for example, be found at [www.osram.com](http://www.osram.com).

Some simple light management features are already included in many OT LED drivers, e.g. Touch DIM® or smart grid functionality. For more detailed information on features included in different OT LED drivers, please consult the corresponding technical datasheets.

**Wiring**

**Recommended cables**

For a safe and reliable operation of OT LED drivers, it is mandatory to use only recommended cables on the input and output side and control port where applicable. This ensures that the cable is suitable for the electrical load and that the mechanical connection of the wire terminals and the cable clamp (when available) is safe and working properly.

Recommended cables for input and output are specified in each product's datasheets, which can also be found at [www.osram.com](http://www.osram.com). Please also check the instruction sheets that are delivered with the product for additional information.

**Cable stripping**

Furthermore, to ensure a safe electrical and mechanical connection of the cable in the electrical terminals or the cable clamp, it is mandatory to observe the cable stripping lengths as shown in the figure below. The stripping lengths for (a) and (b) are specified for each product (where applicable) in the respective datasheets.

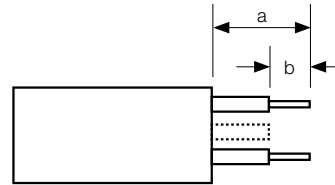

Recommended cable stripping

**Cable routing**

To ensure good radio interference suppression and maximum safety, the following rules for cable routing should be observed:

1. Mains and LED module cables should never be routed in parallel. Keep output cables and mains cables as far away from one another as possible (e.g. 5 to 10 cm). This avoids mutual interference between mains and secondary-side cables.
2. Place output cables away from earthed metal surfaces (if possible several cm) to reduce capacitive interference.
3. LED module cables (to and from the LED driver) have to be kept parallel to reduce radiated emissions.
4. Keep mains cables in the luminaire as short as possible to reduce interference.
5. Do not route mains cables too close to the LED driver (this applies in particular to through-wiring).
6. Avoid crossing mains cables and LED module cables. Where this is not possible, cables should cross at right angles (to avoid HF interference on the mains cable).
7. Cable penetrations through metal components must never be left unprotected and should be fitted with additional insulation (sleeve, grommet, edge protector etc.). Dimming units on the secondary side such as OT DIM usually do not affect the radio interference.

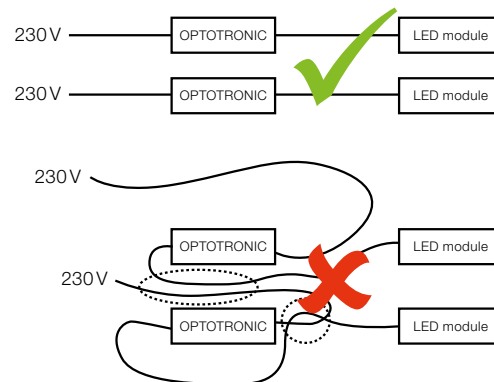

Cable routing of OPTOTRONIC® and LED modules

# Technical application guide OPTOTRONIC® LED drivers for indoor application

## 8 Insulation types

### Updated and new standards for LED drivers

For OSRAM indoor LED drivers, the following insulation classes apply:

- Non-isolated (previously “non-SELV”)
  - No isolation between input and output circuits (LED, LEDset etc.)
- SELV (double/reinforced-isolated):
  - Voltage range:
    - SELV 0–60 V<sub>DC</sub>, all poles touchable, no distance requirements to touchable parts
    - SELV 60–120 V<sub>DC</sub>, one pole touchable
  - Isolating transformer > 120 V<sub>DC</sub>, no pole touchable
- **NEW**
  - SELV in IEC 61347-1:2012, annex L, according to current standard IEC 61347-2-13:2014
  - Normal requirements on creepage distances and clearances, aligned with other safety standards (e.g. IEC 60598-1 safety of luminaires)
- PHASE-OUT
  - SELV in annex I according to previous standard IEC 61347-2-13:2006
    - Very high requirements on creepage distances and clearances
    - High requirements on transformer isolation (thickness through isolation [dti]) and construction
    - Special requirements for higher level of safety, e.g. distance between input and output connector
  - SELV-equivalent according to previous standard IEC 61347-2-13:2006 → IEC 60065 (safety for audio/video)
    - Normal requirements on creepage distances and clearances
    - Low requirements on transformer isolation (thickness through isolation [dti]), small constructions possible

### Non-isolated drivers

Non-isolated (previously “non-SELV”) drivers have no isolation between the primary and secondary side and a basic insulation (single isolation foil) between all the electronic circuits and the driver casing. The corresponding insulation classes are similar to those of typical fluorescent ECGs.



Typical example of a non-isolated driver

Non-isolated OPTOTRONIC® LED drivers belong to protection class I. Non-isolated LED drivers can be used in class I and class II luminaires. The use in class II luminaires may require additional efforts and must be approved by OSRAM.

### Note:

- All output connections of these drivers are not safe to touch
- This also applies to the LEDset interface (R<sub>set</sub> must have basic insulation)

### Insulation matrix for non-isolated indoor drivers

Port	L/N	EQUI or F.E. (functional earth)	Control (DALI, Touch DIM®, 1...10V)	LEDset/ NTCset	Output LED	Casing/PE
L/N	–	Double/ reinforced	Basic	–	–	Basic
EQUI or F.E. (functional earth)	Double/ reinforced	–	Double/ reinforced	Double/ reinforced	Double/ reinforced	Supplementary
Control (DALI, Touch DIM®, 1...10V)	Basic	Double/ reinforced	–	Basic	Basic	Basic
LEDset/ NTCset	–	Double/ reinforced	Basic	–	–	Basic
Output LED	–	Double/ reinforced	Basic	–	–	Basic
Casing/PE	Basic	Supplementary	Basic	Basic	Basic	–

Basic + Supplementary = Double/reinforced

Controller already with basic insulation

### SELV (isolated) drivers

For SELV drivers with up to 60V<sub>DC</sub>, there are lower isolation requirements for luminaire constructions because 60V<sub>DC</sub> is touchable.

All built-in SELV drivers with plastic casing:

- fulfill the requirements of IEC 61347-1, annex O, for double or reinforced insulation
- can also be used independently with an additional cable clamp
- can be used both in class I and class II luminaires

### Insulation matrix for SELV indoor drivers

Port	L/N	EQUI or F.E. (functional earth)	Control (DALI, Touch DIM®, 1...10V)	LEDset/ NTCset	Output LED	Casing: protec- tion class I	Casing: protec- tion class II
L/N	–	Double/ reinforced	Basic	Double/ reinforced	Double/ reinforced	Basic	Double/ reinforced
EQUI or F.E. (functional earth)	Double/ reinforced	–	Double/ reinforced	Basic	Basic	Supplementary	Double/ reinforced
Control (DALI, Touch DIM®, 1...10V)	Basic	Double/ reinforced	–	Double/ reinforced	Double/ reinforced	Basic	Double/ reinforced
LEDset/ NTCset	Double/ reinforced	Basic	Double/ reinforced	–	–	Basic	Double/ reinforced
Output LED	Double/ reinforced	Basic	Double/ reinforced	–	–	Basic	Double/ reinforced
Casing: protection class I	Basic	Supplementary	Basic	Basic	Basic	–	N/A
Casing: protection class II	Double/ reinforced	Double/ reinforced	Double/ reinforced	Double/ reinforced	Double/ reinforced	N/A	–

Basic + Supplementary = Double/reinforced

Controller already with basic insulation

## Overview of OPTOTRONIC® (OT) drivers

Product family		Output voltage [V]	Output current [mA]	Ambient temperature range [°C]	Suitable for luminaires with prot. class
<b>OTi DALI Linear SELV</b>	OTi DALI 35/220-240/700 LT2 L	20...54	200...700	-25...+60	I*
	OTi DALI 50/220-240/1A4 LT2 L	20...54	600...1400	-25...+50	I*
	OTi DALI 80/220-240/1A6 LT2 L	20...54	600...1550	-25...+50	I*
	OTi DALI 80/220-240/2A1 LT2 L	20...54	1000...2100	-25...+45	I*
<b>OTi DALI Linear non-isolated</b>	OTi DALI 60/220-240/550 D LT2 L	54...240	120...550	-25...+60	I*
	OTi DALI 90/220-240/1A0 LT2 L	54...240	250...1000	-25...+50	I*
<b>OT FIT SELV</b>	OT FIT 35/220-240/700 CS L	27...54	700; 600; 500	-20...+50	I*
	OT FIT 50/220-240/1A0 CS L	27...54	1050; 925; 800	-20...+50	I*
	OT FIT 80/220-240/1A6 CS L	27...54	1550; 1400; 1200	-25...+50	I*
<b>OTi non-isolated</b>	OTi 60/220-240/550 D LT2 L	54...240	120...550	-25...+60	I*
	OTi 90/220-240/1A0 D LT2 L	54...240	250...1000	-25...+50	I*
<b>OT FIT non-isolated</b>	OT FIT 30/220-240/125 D L	54...215	125	-25...+50	I*
	OT FIT 50/220-240/250 D L	54...215	250	-25...+50	I*
	OT FIT 50/220-240/350 D L	54...150	350	-25...+50	I*
<b>OTi DALI Compact SELV</b>	OTi DALI 25/220-240/700 LT2	12...54	180...700	-20...+50	I; II
	OTi DALI 35/220-240/1A0 LT2	15...54	350...1050	-20...+50	I; II
	OTi DALI 50/220-240/1A4 LT2 FAN	15...54	600...1400	-20...+50	I; II
<b>OT ECO PC Compact SELV</b>	OTe 10/220-240/700 PC	7...14	700	-20...+55	I; II
	OTe 13/220-240/350 PC	18...38	350	-20...+55	I; II
	OTe 18/220-240/350 PC	27...54	350	-20...+55	I; II
	OTe 18/220-240/500 PC	18...36	500	-20...+55	I; II
	OTe 25/220-240/700 PC	18...36	700	-20...+50	I; II
	OTe 35/220-240/700 PC	27...50	700	-20...+45	I; II
<b>OT FIT Compact SELV</b>	OT FIT 15/220-240/350 CS	27...54	250; 300; 350	-25...+50	I; II
	OT FIT 25/220-240/500 CS	27...54	400; 450; 500	-25...+50	I; II
	OT FIT 35/220-240/700 CS	27...54	550; 600; 700	-25...+50	I; II
	OT FIT 50/220-240/1A0 CS	27...54	800; 900; 1050	-25...+50	I; II
<b>OT ECO Compact SELV</b>	OTe 25/220-240/420 CS	27...54	290; 350; 420	-20...+50	I; II
	OTe 25/220-240/700 CS	18...36	500; 600; 700	-20...+50	I; II
	OTe 35/220-240/700 CS	27...54	500; 600; 700	-20...+55	I; II
	OTe 35/220-240/700 CS S	27...54	500; 600; 700	-20...+50	I; II
	OTe 35/220-240/1A0 CS	17...34	800; 925; 1050	-20...+55	I; II
	OTe 35/220-240/1A0 CS S	17...34	800; 925; 1050	-20...+50	I; II
	OTe 50/220-240/1A0 CS	27...54	800; 925; 1050	-20...+50	I; II
	OTe 50/220-240/1A4 CS	18...36	1150; 1250; 1400	-20...+50	I; II
	OTe 50/220-240/1A0 CS FAN	27...54	700; 900; 1050	-20...+50	I; II

\* Special permission for protection class II luminaires on request

### Hints for the use of non-isolated drivers in class II luminaires

#### Metal luminaires of class II

LED drivers have basic insulation. LED modules should also have basic insulation. In addition, both LED driver and LED modules should be additionally isolated by supplementary insulation. All isolations should be designed according to  $U_{out}$  of the LED driver.

#### Plastic luminaires of class II

All active parts (LED modules) should be protected by at least a basic insulation if the luminaire can be opened for maintenance. The best solution is a sealed luminaire where the LED modules and the driver are not touchable – ideally with a separated connection area.

# Technical application guide OPTOTRONIC® LED drivers for indoor application

## 9 Dimming principles

### Hybrid dimming

OPTOTRONIC® DALI drivers can be dimmed between 100 % and 1 %. In order to cover this wide range, two dimming methods (hybrid dimming) are combined:

- Dimming by amplitude modulation  
The dimming range between 100 % and about 30 % (depending on LED driver) is controlled by adjusting the amplitude of the current. The current value specified for the device corresponds to a dimming level of 100 %. The amplitude of the current is reduced to dim the lighting down.
- Dimming by Pulse Width Modulation (PWM)  
The dimming range between about 30 % and 1 % is controlled by pulse width modulation. PWM dimming is beneficial at lower dimming levels as there are no color and brightness differences between the individual LEDs.

The transition between the two dimming methods is seamless.

### Hybrid dimming

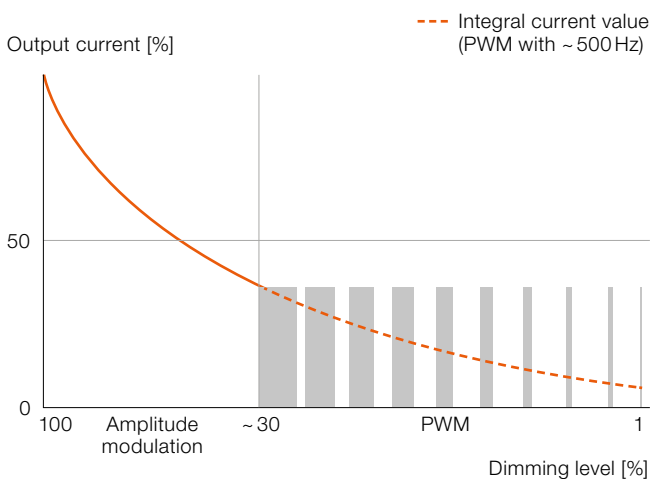

### Phase-cut dimming

Phase-cut dimming is a popular kind of dimming. OPTOTRONIC® ECO (OTe) Phase Cut drivers allow LED modules to be dimmed with phase-cut dimmers. Both trailing-edge and leading-edge phase-cut dimmers can be used. An up-to-date list of suitable dimmers can be found in the OSRAM OEM Download Center at [www.osram.com/oem-download](http://www.osram.com/oem-download).

### Driver for phase-cut dimming



The phase-cut dimmable OTe LED drivers can be integrated into DALI installations with a DALI dimmer (HTi DALI 315 DIM), which converts the DALI dimming commands into trailing-edge dimming signals.

# Technical application guide OPTOTRONIC® LED drivers for indoor application

## 10 Ripple current and “light modulation”



**General**

Light modulation describes how much the instantaneous value of the luminous flux is varying. Human perception strongly depends on the frequency.

Currently, various organisations such as IEEE, CIE or NEMA are discussing very diverse metrics, a dominant market consensus, however, is not yet visible. In general, the relevance of light modulation decreases towards higher frequencies. Frequencies above 3kHz are usually regarded as un-critical, while 100Hz are undoubtedly of high importance.

In practice, many drivers naturally deliver a high content of 100-Hz modulation. The root cause for this is the European 50-Hz mains supply, which results in 100Hz after rectification. Compared to traditional fluorescent light sources, LEDs instantaneously translate their operating current into light, without much smoothing effects. Already minor imperfections of the driver can lead to a low quality of light.

The OPTOTRONIC® LED driver family ensures that the 100-Hz light modulation is so small that it normally cannot be perceived by the human eye and is therefore not critical within a standard application.

The most common definition for the light modulation is:

$$\text{Light modulation} = \frac{\phi_{\max} - \phi_{\min}}{\phi_{\max} + \phi_{\min}}$$

(where  $\phi$  is luminous flux)

On one hand, 100Hz is already high enough that humans do not notice it anymore. On the other hand, it strongly affects video, television and film recording. Applications with demanding requirements, such as optical in-process inspection with CCD cameras, may call for further improvements. In such cases, the use of OTi DALI SELV LED drivers with a ripple current of 1...3% (pure amplitude dimming between 100 and 30%) is recommended.

**Output ripple current (100 Hz) of different driver technologies**

Fluorescent lamp ECG: QUICKTRONIC®		LED driver: OPTOTRONIC®	
QTi DALI/QTi...DIM	< 10%	OTi DALI	1...3% SELV, 1...10% non-isolated
QTP OPTIMAL	< 10%	OTi	< 10%
QT FIT	< 10%	OT FIT	5%
		OTe	20...35%*
Magnetic gear	25...35%		

\* Strongly depends on the LED module

In addition to economic and ecological aspects, the use of ECGs and LED drivers with low levels of light modulation has extremely positive effects on the working environment. In general, strong flickering at low frequencies should be avoided. It is known that a small subgroup of patients with epilepsy are photosensitive and react to flickering light. The risk for such reactions drastically reduces when the frequency of the light modulation is increased to over 70Hz.

Even when there is no obvious visible flicker, ergonomics studies with conventional technology (CCG operation) have shown that latent flickering of the light is a load factor that affects a person’s work performance, particularly at VDU workstations. The consequences are rapid fatigue, lack of concentration and a greater number of errors in word processing and other such tasks. Practical VDU-based tasks have shown that the benefits of flicker-free light are considerable, not only for the people themselves but also for the quality of their work. Premium-quality LED drivers produce less than 5% modulation, and are therefore often called “flicker-free” or “zero ripple”.

**Definition and measurement (ripple current)**

In most cases, the light modulation is proportional to the ripple current.

$$\text{LF ripple current} = \frac{I_{LF\max} - I_{LF\min}}{I_{LF\max} + I_{LF\min}}$$

LF = Low Frequency

**Measurement**

In a first approximation, the light modulation is proportional to the current modulation, often called ripple current. This proportional behavior allows the light modulation to be judged by performing a current measurement. A low-pass filtered current measurement achieves the most accurate results. If no filter is available, a simplified measurement method can be used.

**Simplified measurement**

- Measurement of module current
- No filter necessary
- Readings from upper envelope (100 Hz)
  - Typical accuracy : +/-15% of result
  - Means: 20% varies between 17...23%
- A light measurement with a photodiode, phototransistor or integrated light-to-voltage converter will deliver almost identical results
- If PWM is used: modulation = 100%
- Most common behavior over time: increase of the ripple current due to capacitor aging

**Simplified measurement**

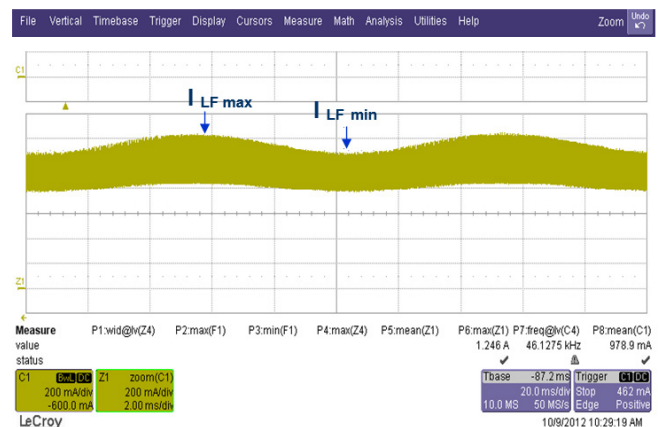

### Advantages and disadvantages of PWM

Advantages of PWM dimming:

- Dimming without color differences among all LEDs
- Same brightness of all LEDs

Disadvantages of PWM dimming:

- Remaining risk of stroboscopic effects when rotating or fast-moving parts are illuminated; this risk can be reduced by increasing the PWM frequency to over 400–500Hz
- Interference effects with cameras are reduced with higher frequency, but for high demands on image quality or high-speed imaging, PWM is not recommended

### Hybrid dimming

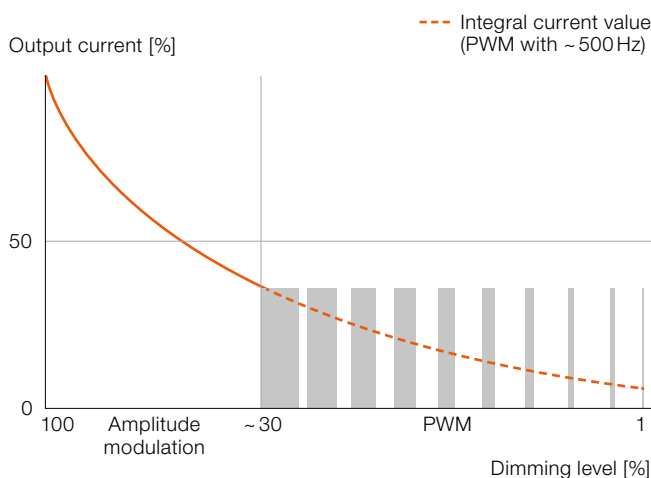

### Segments of ripple current (application clustering)

Ripple current	Applications
a) 0–10 %	Factories with rotating machines, camera-controlled areas, scanner applications, film recording, hospitals
b) 10–35 %	Offices and standard illumination applications
c) 35–50 %	Corridors, car parks, outdoor and peripheral areas

### Overview of some system combinations

System	Dimming level	Modulation [%] (percent flicker)
PLSZ2-LIN-4000-830-560 & OTi DALI 35/220-240/700 LT2 L (dimmer: DALI MCU)	low dimming level	100.0
PLSZ2-LIN-4000-830-560 & OTi DALI 35/220-240/700 LT2 L (dimmer: DALI MCU)	approx. 50 %	1.3
PLSZ2-LIN-4000-830-560 & OTi DALI 35/220-240/700 LT2 L	not dimmed	1.0
PLSZ2-LIN-4000-830-560 & OTi DALI 50/220-240/1A4 LT2 L	not dimmed	0.9
PLSZ2-LIN-4000-830-560 & OTi DALI 80/220-240/1A6 LT2 L	not dimmed	1.1
PL-CN111-2700-830-24D-G1 & OTi DALI 25/220-240/700 LT2	not dimmed	0.9
PL-CN111-2700-830-24D-G1 & OTe 35/220-240/700 CS S (700mA)	not dimmed	34.7
PL-CN111-2700-830-24D-G1 & OTe 35/220-240/700 CS S (600mA)	not dimmed	33.8
PL-CUBE-AC-2000-830-G2	not dimmed	30.2
PL-CORE AC-800-830	not dimmed	100.0

# Technical application guide

## OPTOTRONIC<sup>®</sup> LED drivers for indoor application

### 11 Emergency lighting with central and local battery systems

## Emergency lighting with central battery systems

### General

OPTOTRONIC® constant-current LED drivers such as OTi DALI, OTi and OT FIT are suitable for DC operation (e.g. central emergency system) in compliance with IEC 61347-2-13, annex J, which is stated with the EL mark. Additionally, all OPTOTRONIC® LED drivers are tested according to IEC 60598-2-22 (standard for luminaires for emergency lighting), where the luminaires have to operate reliably at an ambient temperature  $T_a$  of 70 °C within half of the rated duration.

1. For the total test of the luminaire at an ambient temperature  $T_a$  of 70 °C.
2. In case of an emergency, the luminous flux is not allowed to fall below 50 % within half of the rated duration (e.g. 3h → 1.5h or 1h → 30min). The luminous flux at the beginning of the emergency operation is of main importance. This “emergency” luminous flux can be much smaller than 100% of the general lighting level, e.g. 15 %.

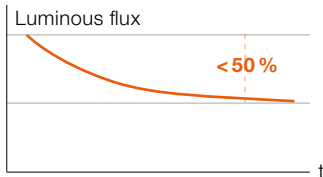

### Voltage ranges and switch-on/switch-over times

	Permitted DC voltage range	Switch-over times: Maintained supply is switched from AC to DC	Switch-on times: Non-maintained emergency luminaires are switched on from cold	Driver output current in DC mode/ not locked
OTi DALI	176–276 V <sup>1)</sup>	0.2 s	0.3 s <sup>2)</sup> , 0.6 s <sup>3)</sup>	15 % <sup>4)</sup>
OTi	176–276 V <sup>1)</sup>	<0.5 s	<0.5 s	15 % <sup>4)</sup>
OT FIT	176–276 V <sup>1)</sup>	<0.5 s	<0.5 s	100 %

- 1) DC or pulse DC (> 198V for starting)
- 2) Switch-on time when emergency mode is activated
- 3) Switch-on time when emergency mode is not activated (at 230V, 50Hz, full load, according to DALI standard)
- 4) Output current/not locked

### Output current in DC mode

Depending on the LED driver type, there are different output current and light levels in DC operation.

OTi DALI and OTi (non-dimmable) drivers can detect DC voltage and operate at a default output current of 15 % in DC mode to reduce battery consumption. If a higher output current is required, the default value can be adjusted via DALI magic/Wizard or DALI magic/Tuner4TRONIC®.

In DC operation, non-dimmable OSRAM LED drivers such as OT FIT typically have the same output (100 % output current) as in AC operation.

**Note:** OSRAM can only provide data for the LED drivers. As the IEC requires luminous flux specifications (lm), the luminaire manufacturer has to validate his emergency luminaires (influence of LED module and luminaire construction).

For more detailed information about IEC 60598-2-22 in respect to LED drivers, please refer to the OEM News “OEM-Information for emergency fittings acc. to IEC 60598-2-22” (02.09.2014) or the OSRAM OEM Download Center at [www.osram.com/oem-download](http://www.osram.com/oem-download).

### Adjustment of the emergency lighting parameters

As mentioned above, DALI LED indoor drivers have a default output of 15 % and are not locked. This means that if the DALI LED drivers detect DC voltage, they automatically change to an output of 15 % and do no longer accept DALI commands to avoid unwanted output levels. Connected sensors are also ignored.

For central battery emergency installations where the factory settings do not fit, it is possible to adjust the emergency lighting parameters of OSRAM DALI LED drivers. For this adjustment, OSRAM offers two options:

### 1. The software DALI Wizard in combination with the hardware DALI magic

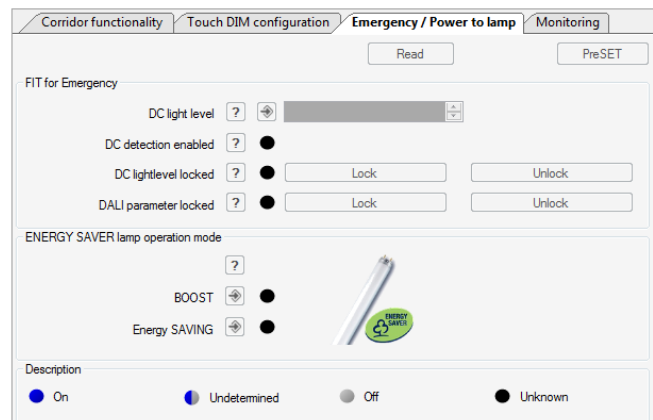

DALI magic hardware

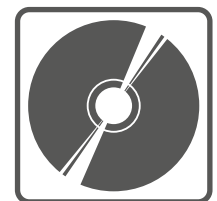

DALI Wizard software

### 2. The software Tuner4TRONIC® in combination with the hardware DALI magic (more details can be found in the Tuner4TRONIC® Development manual)



Possible adjustments in the emergency mode

### Compatibility with central battery systems

In many emergency lighting installations with central battery systems, compatibility of LED drivers with established emergency lighting monitoring systems is a must. Therefore, OSRAM and, for example, EATON-CEAG and INOTEC have tested the compatibility of OSRAM LED drivers and DALI LED drivers with emergency luminaire monitoring modules.

For DALI installations, EATON-CEAG and INOTEC recommend their DALI-addressing components.

### Emergency lighting standards permit direct DALI communication for emergency luminaires in DALI installations

Due to the increasing attractiveness of DALI installations, DALI communication is used more and more in emergency lighting installations. The benefits are that general lighting luminaires and emergency luminaires use the same components and emergency luminaires do not lose CE approval, e.g. when adding luminaire monitoring modules. Depending on the application, each emergency luminaire can easily be adjusted via DALI, i.e. each emergency luminaire is controllable and can easily be monitored. First projects with direct DALI communication are carried out by OSRAM and Schuster in the automotive industry and office buildings.

Requirements for LED controlgears			
Manufacturer:	Type / description:		
OSRAM GmbH Marcel-Breuer-Strasse 6 80807 München	ECG-family: OTI DALI 50 220-240 1A4 LT2 FAN		
CEAG-Data:	CEAG data:	Comment:	Complies:
Operating voltage range DC:	DC 180 V - 270 V at -10 °C	Possible voltage range of the battery in emergency mode (not necessary for AT-SV System)	YES
Switching time from AC to DC and DC to AC:	180 ms - 450 ms 180 ms - 450 ms	Typical switch over time of CEAG CPS/UPS-devices	YES
Starting characteristic controlgear:	Stable current consumption lower after 1.8 s	necessary for selective control 11 - 12.5 mA per luminaire, at max. 20 luminaires for one control circuit, 1.8 for system < 200 mA	YES
Fulfilled the standard:	DIN EN 62384	DC Or AC supplied electronic control gear for LED modules - Performance requirements	YES
Fulfilled the standard:	DIN EN 61347-2-13	Lamp controlgear - Part 2-13: Particular requirements for AC or DC supplied electronic controlgear for LED modules	YES
Fulfilled the standard:	DIN EN 55015 (Measurement on AC And DC)	Limits and methods of measurement of radio disturbance characteristics of electrical lighting and similar equipment	YES
Fulfilled the standard:	DIN EN 61000-3-2	Electromagnetic compatibility (EMC) - Part 3-2: Limits - Limits for harmonic current emissions (equipment input current < 16 A per phase)	YES
Fulfilled the standard:	DIN EN 61000-3-2, (No. 7.3.4)	is foreseen necessary for AT-SV Systems special for LED driver(s) (sinusoidal current draw)	YES
Fulfilled the standard:	DIN EN 61547	Equipment for general lighting purposes - EMC immunity requirements	YES
LED module fulfills the standard:	DIN EN 60521	LED modules for general lighting - Safety specifications	N/A
CEAG data not available or ECG, reference or separate			
Features	CEAG-Data:	Comment:	Manufacturer's instructions:
No load current of the ballast (without tube or with defect tube) in DC-operation	V-CG-SB.1	selection aid for monitoring modules also for identification of the max. luminaire quantity per circuit and the required battery capacity. These values are not allowed to be failed below def. limits for the voltage range of 180 - 270V DC and 180 - 240 V AC (for AT-SV Systems must be the current draw sinusoidal (see DIN EN 61000-3-2, clause 7.3.4))	see "OTI DALI 50 220-240 1A4 LT2 FAN"
voltage dependent - No load current of the ballast (without or with defect LED module) in DC and AC-operation:	V-CG-SB.1	selection aid for monitoring modules. These values are not allowed to exceed the def. limits for the voltage range of 180 - 270V DC and 180 - 240 V AC (for AT-SV Systems must be the current draw sinusoidal (see DIN EN 61000-3-2, clause 7.3.4))	see "OTI DALI 50 220-240 1A4 LT2 FAN"
Max. inrush current each component/module in AC-operation:	Max. permitted inrush current per circuit: 30kV x 3A (CO) => 120 A 30kV x 4A (CO) => 160 A 30kV x 1.5A CO-S => 60 A 30kV x 2A CO-S => 80 A 30kV x 4A CO-S => 280 A 30kV CO-S / S' => 280 A 30kV S'	Describes the max. inrush current of all ballasts in a circuit, to calculate the maximum contact rating of the circuit.	see "OTI DALI 50 220-240 1A4 LT2 FAN"
Lightstart in DC-operation at 180 V in comparison to 230 V AC operation:	-	in battery operation of the ballast, for the light calculation	
ECG family: OTI DALI 50 220-240 1A4 LT2 FAN Luminaires, which are used for emergency lighting, must be according to the standard DIN EN 60598-2-22 (particular requirements - Luminaires for emergency lighting) and DIN EN 60541 (classification group 1 (photobiological safety for lamps and lamp systems)) Control of function is done via DALI-Driver In case of defective LED-module, the DALI-Driver OTI DALI 50 22-240 1A4 LT2 FAN has to be switched off via DALI command "0" to prevent possible disturbances of CEAG-communication Max. 1 DALI-Driver OTI DALI 50 L to wire with 1 V-CG-SB.1 IPC inside OTI DALI 50 L Sinneg 07-2014			

Technische Anforderungen an elektrische Betriebsgeräte (EVGs) zum Anschluss an INOTEC Zentralbatteriergeräte			
Hersteller EVG:		Typ / Bezeichnung:	
OSRAM GmbH; Marcel-Breuer-Str. 6; 80807 München		OTI DALI 90/220-240/1A0 LT2 L AA41286 / AA67888	
Projekt / Projektort:		Projektnummer:	
Merkmale	Techn. Daten / INOTEC Anforderung	Erklärung	Erfüllt (Ja / Nein)
Betriebespannungsbereich AC	230V ± 10%	Spannungsbereich im Netzbetrieb	Ja
Betriebespannungsbereich DC	180V - 260V	Möglicher Batteriespannungsbereich im Notstrombetrieb	Ja
Betriebsgerät geeignet für "Loker-Spannung" ?	Ungeplante Gleichspannung - (Hochgeklappte Halbwelle)		Ja
Betriebsgerät kompatibel mit der Umschaltzeit der Anlage ?	Umschaltzeit: von AC auf DC: 150 - 1000ms von DC auf AC: 150 - 1000ms	Typische Umschaltzeit von INOTEC Anlagen zwischen Netz- und Ersatzstromquelle	Ja
Abschaltzeit des EVG (bei defektem Leuchtmittel) im DC Betrieb	innerhalb von 3s	Notwendig für Erkennung eines defekten Leuchtmittels	DAI Lamp failure
Merkmale	Techn. Daten / INOTEC Anforderung	Erklärung	Angabe Hersteller
Nennstrom des EVGs im DC Betrieb bei engstem Lichtstromverhältnis	I-SV-Modul/S (5-120W) > 20mA I-SV-Modul 2/S (20-300W) > 70mA I-SV-Modul 4/S (2-30W) > 12mA I-SV-Modul 4/S (18-120W) > 70mA I-SV-Modul 4/S (20-120W) > 20mA	Auswahlhilfe Überwachungsmodul. Diese Werte dürfen im Spannungsbereich 180 - 260V DC nicht unterschritten werden, damit die Leuchte als OK gemeldet wird.	> 20 mA
Leuchtdrom des Betriebsgerätes (ohne oder defektes Leuchtmittel) im DC Betrieb	I-SV-Modul/S (5-120W) < 30mA I-SV-Modul 2/S (20-300W) < 8mA I-SV-Modul 4/S (2-30W) < 8mA I-SV-Modul 4/S (18-120W) < 45mA I-SV-Modul 4/S (20-120W) < 10mA	Auswahlhilfe Überwachungsmodul. Diese Werte dürfen im Spannungsbereich 180 - 260V DC nicht überschritten werden, damit ein defektes Leuchtmittel als Fehler gemeldet wird.	< 10 mA
Nennstrom des EVGs im AC Betrieb		Auswahlhilfe Stromkreiseinschub	430 mA
Max. Einschaltstrom des EVGs	80A / 500µs (für alle I-SV-Module)	Bezieht sich auf den maximalen Einschaltstrom des EVGs im Überwachungsmodus	53/200 A / µs
Max. Einschaltstrom der EVGs je Stromkreis	SK 4x2A: 250A / 500µs SK 2x4A: 250A / 500µs SK 1x6A: 250A / 500µs	Bezieht sich auf den maximalen Einschaltstrom der Leuchten in einem Stromkreis, um die maximale Kontaktbelastbarkeit der Stromkreisschaltungen berücksichtigen zu können	N/A A / µs
Lichtstromverhältnis im DC Betrieb		Lichtstrom im Batteriebetrieb zur Lichtplanung	158

Leuchten, die für den Einsatz als Sicherheitsleuchte vorgesehen sind, müssen u.a. der Norm DIN EN 60598-2-22 (Besondere Anforderungen - Leuchten für Notbeleuchtung) entsprechen.

Stand: Apr. 2014

INOTEC\_Anforderungen an Betriebsgeräte

Typical confirmation papers from EATON-CEAG and INOTEC

### Emergency lighting companies for central battery systems

OSRAM DALI LED drivers	Emergency lighting company	Recommended emergency lighting device	Comment
	EATON-CEAG	V-CG-SB.1	
	INOTEC	DALI SV-Modul 851 032	
	Gessler, Rodgau	LB01/009 DD	
	Gessler, Rodgau	No need	<b>SIBELON</b> – directly addressing DALI drivers
	Schuster, Grevenbroich	SET 009 DD SET 010 DD	
	Schuster, Grevenbroich	No need	<b>SETLON</b> – directly addressing DALI drivers
	ASE, Kaarst	SET 010 DD	
	ASE, Kaarst	No need	<b>SETLON</b> – directly addressing DALI drivers
	Siemens, Regensburg	No need	KNX/DALI Gateway, Plus/Twin plus directly addressing DALI drivers monitoring the AC installation

Additional compatibility information of other OSRAM LED drivers can be found in the OSRAM OEM Download Center at [www.osram.com/oem-download](http://www.osram.com/oem-download).

## Emergency lighting with local battery systems

### Compatibility with local battery systems

In order to achieve compatibility with local battery systems, topics such as compatibility of the output voltage range, switch-over sequence and the fulfillment of the SELV requirements of the system are important.

OSRAM and Mackwell have carried out intensive tests regarding:

- Compatibility of the output operating range
- Behavior at range limits
- Switch-over sequence (switch-over criteria such as overvoltage/undervoltage or switch-over time)

The tests have been performed with actual EL converters. Regularly updated compatibilities can be found in the OSRAM OEM Download Center at [www.osram.com/oem-download](http://www.osram.com/oem-download).

### Components and combinations

Emergency unit: Mackwell, ELEDD55 and ELEDD55/D1 (DALI version)

Battery pack: LabType, NiCd, 4.8V/2Ah

#### LED modules

- PL-CORE-Z4-1100/2000/3000/5000-8XX
- PL-CUBE-2000/3000-8XX-0.5A/0.7A-G1
- PLVZ1-LIN-650-8XX-280-DC
- PLVZ1-LIN-1300/2200-8XX-560-DC

#### LED drivers

- DALI or non-DALI
- OT FIT 25/220-240/500 CS and  
OT FIT 35/220-240/700 CS
  - OTi DALI 50/220-240/1A4 LTS FAN
  - OTi DALI 50/220-240/1A4 LT2 L

### Wiring diagram for LED driver, LED module and EL-kit

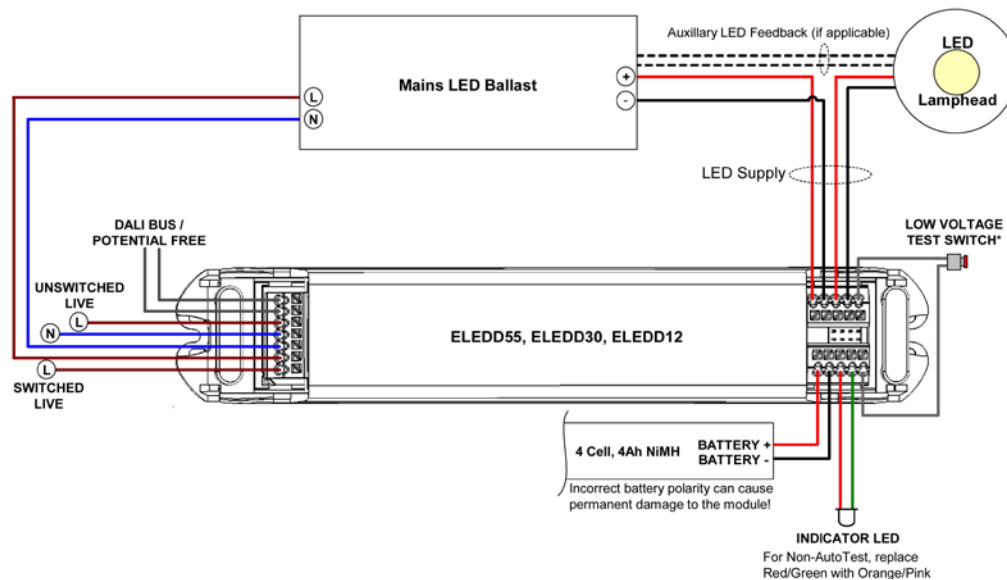

### Functional description and wiring of the emergency lighting unit

The emergency lighting unit ELEDD55 detects the level of the mains supply and switches the LED operation from regular operation (mains-powered LED driver) to emergency operation (DC/DC converter integrated in the emergency lighting unit). If the mains supply drops below a threshold, the unit switches off the mains-powered LED driver and operates the LED module at 50–90 mA from the integrated converter. If the mains recovers above the threshold, the unit switches back to the mains-powered LED driver. Switching between regular and emergency operation involves two relays: A primary-side relay that opens/closes the L supply for the mains-powered LED driver and a secondary-side multi-contact relay that switches the load connection from the mains-powered LED driver to the DC/DC converter or vice versa. The secondary-side relay is a dual-pole type.

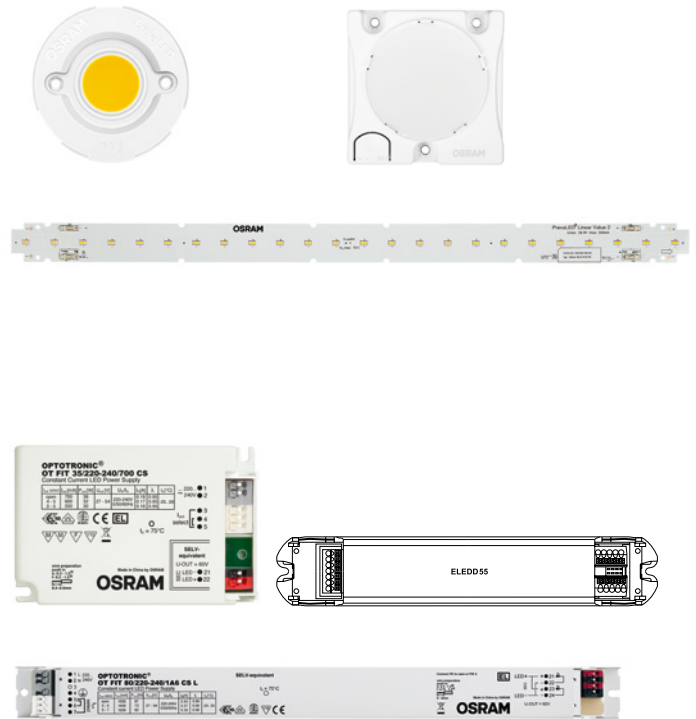

### Permitted OSRAM/Mackwell combinations

OSRAM LED module	OSRAM LED driver		Mackwell ELEDD55		Mackwell ELEDD55/D1		Light color 8XX=	
	Number	Combina- tion LED driver	Fit for EL unit & LED driver	Fit for EL unit & LED module	Fit for EL unit & LED driver	Fit for EL unit & LED module		
PL-CORE-Z4-2000-8XX	1	1s1p	OT FIT 25/220-240/500 CS	Ok	Ok	Ok	Ok	827, 830, 835, 840
PL-CORE-Z4-3000-8XX	1	1s1p	OT FIT 35/220-240/700 CS	Ok	Ok	Ok	Ok	827, 830, 835, 840
PL-CORE-Z4-5000-8XX	1	1s1p	OT FIT 50/220-240/1A0 CS	Ok	Ok	Ok	Ok	830, 835, 840
PL-CORE-Z4-5000-8XX	1	1s1p	OTi DALI 50/220-240/1A4 LT2 FAN	Ok	Ok	Ok	Ok	830, 835, 840
PL-CUBE-2000-8XX-0.5A-G2	1	1s1p	OT FIT 25/220-240/500 CS	Ok	Ok	Ok	Ok	830, 840
PL-CUBE-2000-8XX-0.5A-G2	1	1s1p	OT FIT 35/220-240/700 CS	Ok	Ok	Ok	Ok	830, 840
PL-CUBE-3000-8XX-0.7A-G2	1	1s1p	OT FIT 35/220-240/700 CS	Ok	Ok	Ok	Ok	830, 840
PL-CUBE-2000-840-0.5A-G2	1	1s1p	OTi DALI 25/220-240/700 LT2	Ok	Ok	Ok	Ok	830, 840
PL-CUBE-3000-8XX-0.7A-G2	1	1s1p	OTi DALI 25/220-240/700 LT2	Ok	Ok	Ok	Ok	830, 840
PL-CUBE-2000-840-0.5A-G2	1	1s1p	OTi DALI 35/220-240/1A0 LT2	Ok	Ok	Ok	Ok	830, 840
PL-CUBE-3000-8XX-0.7A-G2	1	1s1p	OTi DALI 35/220-240/1A0 LT2	Ok	Ok	Ok	Ok	830, 840
PL-CUBE-3000-8XX-0.7A-G2	1	1s1p	OT FIT 50/220-240/1A0 CS	Ok	Ok	Ok	Ok	
PLVZ1-LIN-1300-8XX-560-DC	4	1s4p	OTi DALI 50/220-240/1A4 LT2 L	Ok	Ok	Ok	Ok	830, 835, 840, 850
PLVZ1-LIN-1300-8XX-560-DC	4	1s4p	OT FIT 50/220-240/1A0 CS L	Ok	Ok	Ok	Ok	830, 835, 840, 850
PLVZ1-LIN-650-8XX-280-DC	4	1s4p	OT FIT 35/220-240/700 CS L	Ok	Ok	Ok	Ok	850

### **To-dos for the luminaire manufacturer**

The following documents and tests have to be prepared/carried out by the luminaire manufacturer to ensure compliance:

- 1.** Test report safety according to EN 60598-2-22
- 2.** Test report EMI according to EN 55015
- 3.** Test report immunity according to EN 61547
- 4.** Test report EMF according to EN 62493 (electromagnetic fields)
- 5.** CE declaration, battery pack is compliant with EN 61951-1/-2 (or test report)
- 6.** CE declaration, EL converter is compliant with EN 61347-2-7 (or test report)
- 7.** CE declaration, EL converter is compliant with EN 62034 (or test report)
- 8.** Test report harmonics according to EN 61000-3-2
- 9.** Colors of status LEDs are compliant with EN 60073
- 10.** Light distribution curve in emergency mode

If ENEC approval is required, the safety documents of point 5, 6 and 7 have to be given to a certified testing institution such as VDE, ÖVE or TÜV.

Further information can be found in the OSRAM OEM Download Center at [www.osram.com/oem-download](http://www.osram.com/oem-download).



# Technical application guide OPTOTRONIC® LED drivers for indoor application

## 12 Abnormal conditions

**Overload**

OPTOTRONIC® LED drivers are equipped with a reversible electronic overload protection, which, in case of an overload condition, automatically reduces the output power or switches off to prevent damage to the LED driver or installation.

When the overload condition is removed, the LED driver returns to its full output power or requires a mains reset. Exceeding the maximum rated load ( $P/P_N > 1$ ) also bears the risk of overheating the driver and can also lead to a safety shutdown.

If an LED driver shuts down due to an overload, it may enter a blinking mode, alternating between a complete shutdown and a brief power-up of the system in order to determine whether the overload condition is still present in the installation.

**Warning:** Operating OPTOTRONIC® LED drivers continuously above the maximum rated power reduces the lifetime of the driver and the maximum  $T_c$  temperature of the driver may also be exceeded.

**Short circuit****Short circuit between both output wires (LED+ and LED-)**

OPTOTRONIC® LED drivers have a reversible electronic protection against damage caused by a short circuit between LED+ and LED-. If a short circuit is detected, the LED driver limits the output power or switches off.

**Short circuit from any output wire to PE**

A short circuit from any output wire to PE means shorting a basic isolation, which is generally not allowed. The functional consequences for non-isolated drivers are different from the consequences for SELV drivers.

- Non-isolated drivers will switch off. The internal fuse of non-isolated OT drivers will blow in compliance with the safety standards.
- SELV drivers will typically tolerate such a short circuit without dramatic malfunction.

**Partial/no load**

OPTOTRONIC® LED drivers ensure safe and reliable operation of LED modules within the complete rated load range. Behavior outside of the rated load range is specified in the individual product datasheet.

**Overtemperature**

OPTOTRONIC® drivers may become overheated due to high-load operation, insufficient cooling or close-by heat sources. Regardless of the source of overheating, OPTOTRONIC® drivers are protected against permanent damage from overtemperature.

Depending on the OPTOTRONIC® family, the driver reduces the output power in case of overtemperature and, also depending on the family, eventually shuts down in order to avoid permanent damage.

**Warning:** For safe and reliable operation and also to avoid a reduction in lifetime, it is mandatory to keep the  $T_c$  temperature below the specified maximum value at all times.

**Input overvoltage**

OPTOTRONIC® drivers are able to withstand high and low mains voltages for a limited time.

1. A high mains AC voltage stresses the driver and has a negative impact on the driver lifetime. Typically, the permitted voltages are 275...350V for a period of 2 to 48 hours.
2. Up to a certain limit, OPTOTRONIC® drivers have a built-in surge protection. A typical surge transient protection is 1 kV between L and N and 2 kV between LN and PE according to EN 61547, clause 5.7. For detailed values, see the individual product datasheets.

Depending on the requirements, an additional surge protection device may be necessary for the protection against high surge pulses.

# Technical application guide OPTOTRONIC® LED drivers for indoor application

## 13 Installation notes

## Residual-current circuit breakers

### Problem

For LED drivers with protective earth (PE), the high short-term inrush current or also the low leakage current from the interference suppression capacitors in the LED drivers can trigger the residual-current circuit breakers.

### Solution

- Distribute luminaires across 3 phases and use 3-phase residual-current circuit breakers
- Use surge-current-resistant, short-delay residual-current circuit breakers
- If permissible, use 30-mA residual-current circuit breakers

## Inrush current/maximum number of LED drivers per miniature circuit breaker (MCB)

A starting current pulse of very short duration (< 1 ms) is generated as the storage capacitor used for internal power supply is charged.

In this case, the simultaneous charging of these capacitors in the LED drivers means a higher system inrush current than with the choke/starter fittings installed before. This reduces the maximum number of LED drivers permitted per MCB.

When using the values in the table on the next page, please note the following:

- Switching is assumed to occur at the peak of the rated AC input voltage, which is the worst case in terms of the inrush current pulse.
- The type of circuit breakers (e.g. Siemens type 5SN I-2 and 5SX) has "B" tripping characteristic.
- If circuit breaker types with "C" characteristic are used, the permitted number of LED drivers is 70 % higher than with "B" characteristic (please observe VDE-0100-410).
- The specified maximum number applies to single-pole automatic circuit breakers. When using multi-pole automatic circuit breakers (2-pole or 3-pole), the permitted number of units is reduced by 20 %.
- Circuit impedance: The specified loading applies with reference to a line impedance of 800 mΩ. This corresponds to a 15-m-long cable with a diameter of 1.5 mm<sup>2</sup> from the distribution board to the first luminaire and a further distance of 20 m to the middle of the circuit. At a line impedance of 400 mΩ, the permitted values are reduced by 10 %. At 200 mΩ, they are reduced by 20 %.

**Max. number of LED drivers permitted on MCBs with B and C characteristic**

Product family		Order number	I max [A <sub>pk</sub> ]	Th [μs]	Max. units per circuit breaker			
					Type B 10A	Type C 10A	Type B 16A	Type C 16A
<b>OTi DALI Linear SELV</b>	OTi DALI 35/220-240/700 LT2 L	4052899245389	32	100	18	31	30	51
	OTi DALI 50/220-240/1A4 LT2 L	4052899028098	53	200	8	14	13	22
	OTi DALI 80/220-240/2A1 LT2 L	4052899028074	53	200	8	14	13	22
	OTi DALI 80/220-240/1A6 LT2 L	4052899028050	53	200	8	14	13	22
<b>OTi DALI Linear non-isolated</b>	OTi DALI 60/220-240/550 D LT2	4052899188662	53	300	8	14	13	22
	OTi DALI 90/220-240/1A0 LT2 L	4008321867568	53	200	8	14	13	22
<b>OT FIT SELV</b>	OT FIT 35/220-240/700 CS L	4052899032828	24	230	17	29	28	48
	OT FIT 50/220-240/1A0 CS L	4052899032804	24	230	17	29	28	48
	OT FIT 80/220-240/1A6 CS L	4052899032781	53	230	8	14	13	22
<b>OTi non-isolated</b>	OTi 60/220-240/550 D LT2 L	4052899188419	53	200	8	14	13	22
	OTi 90/220-240/1A0 D LT2 L	4052899188556	53	200	8	14	13	22
<b>OT FIT non-isolated</b>	OT FIT 30/220-240/125 D L	4052899032828	not relevant	not applicable	35	59	56	95
	OT FIT 50/220-240/250 D L	4052899222571	not relevant	not applicable	35	59	56	95
	OT FIT 50/220-240/350 D L	4052899222595	not relevant	not applicable	35	59	56	95
<b>OTi DALI Compact SELV</b>	OTi DALI 25/220-240/700 LT2	4052899919457	20	< 100	25	42	80	136
	OTi DALI 35/220-240/1A0 LT2	4052899919440	20	< 100	33	56	55	94
	OTi DALI 50/220-240/1A4 LT2 FAN	4052899919433	30	200	12	20	20	34
<b>OT ECO PC Compact SELV</b>	OTe 10/220-240/700 PC	4052899105300	< 5	100	55	93	85	145
	OTe 13/220-240/350 PC	4052899105324	< 5	100	55	93	85	145
	OTe 18/220-240/350 PC	4052899105362	< 5	100	55	93	85	145
	OTe 18/220-240/500 PC	4052899105348	< 5	100	55	93	85	145
	OTe 25/220-240/700 PC	4052899105386	< 7	100	40	68	65	110
	OTe 35/220-240/700 PC	4008321825520	< 10	250	30	51	50	85
<b>OT FIT Compact SELV</b>	OT FIT 15/220-240/350 CS	4052899919426	24	174	17	29	28	48
	OT FIT 25/220-240/500 CS	4052899919419	24	174	17	29	28	48
	OT FIT 35/220-240/700 CS	4052899919402	24	174	17	29	28	48
	OT FIT 50/220-240/1A0 CS	4052899166318	24	174	17	29	28	48
<b>OT ECO Compact SELV</b>	OTe 25/220-240/420 CS	4052899917538	< 16	100	30	51	50	85
	OTe 25/220-240/700 CS	4052899917545	< 16	100	30	51	50	85
	OTe 35/220-240/700 CS	4052899917569	< 16	100	15	25	25	43
	OTe 35/220-240/700 CS S	4052899917552	< 16	100	28	48	44	75
	OTe 35/220-240/1A0 CS	4052899917668	< 16	100	15	25	25	42
	OTe 35/220-240/1A0 CS S	4052899917651	< 16	100	28	48	44	75
	OTe 50/220-240/1A0 CS	4052899917576	< 16	100	15	25	25	43
	OTe 50/220-240/1A4 CS	4052899917583	< 16	100	15	25	25	43
	OTe 50/220-240/1A0 CS FAN	4052899919396	< 16	100	15	25	25	43

### Maximum permitted length of control cables

If dimmers or dimmable drivers are used, every type of dimming has a maximum permitted cable length that must be observed. The table below lists the typical maximum cable lengths that can be achieved with different control protocols without the use of repeater devices.

### Typical maximum control cable lengths

	Typical maximum cable length
1...10V	Depending on type of control cable
DALI	300m
Touch DIM®/ Touch DIM® Sensor	25 m (up to 20 devices), 100m with DALI repeater/25 m (up to 4 devices)
DMX	300m
EASY	100m

OSRAM offers repeater devices for the 1...10V, DALI and EASY control protocols. For further details, please refer to [www.osram.com/lms](http://www.osram.com/lms).

**Warning:** DALI LED drivers with Touch DIM® function must not be operated with open DALI wires!

### Recommendation

As long as no DALI controller is connected to the DALI LED drivers, short-circuit the DALI wires in the sub-distribution cabinet. This is also valid for installations with Touch DIM®/corridor function. Reason: To avoid unwanted switching or unsynchronized dimming caused by electrical distortions or coupling into open DALI wires.

### Technical background

Even low induced voltages can trigger the Touch DIM® mode on the DALI input connector of the DALI LED drivers. This antenna effect depends on the length and position of the open DALI line. With an open DALI line of more than 10 m, we recommend to short-circuit the DALI line.

### How to repair (reset)

If the DALI drivers are already triggered incorrectly into Touch DIM® mode:

1. Interrupt the mains to the DALI drivers and connect a DALI control unit to the DALI input of the DALI LED drivers (e.g. OSRAM DALI Repeater or DALI MCU).
2. After powering up the DALI LED drivers again, the DALI drivers will check if a DALI signal is connected to the DALI input of the driver and will switch back into DALI mode again.
3. Interrupt the mains again, disconnect the DALI control unit.
4. Short-circuit the DALI line.
5. Then power on again.

This information is valid for DALI LED drivers with Touch DIM®/corridor function and for DALI ECGs for fluorescent lamps.

### No parallel connection on the output side

OPTOTRONIC® LED drivers cannot be connected in parallel on the secondary side as this may lead to unequal load distribution and overload of individual drivers. Series connection is also not permitted.

### Parallel connection of OPTOTRONIC® drivers

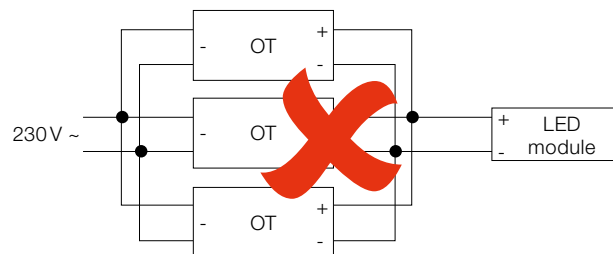
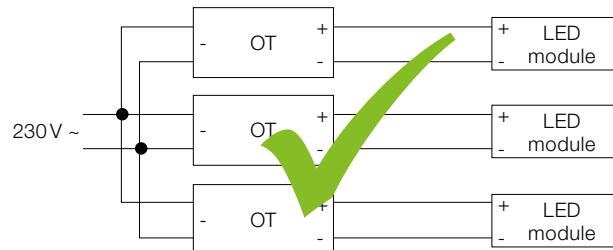

The exception are the constant-voltage drivers OT 50 E and OT 75 E, which are designed to allow a parallel connection of up to five (OT 50/120-277/10 E) or four drivers (OT 75/120-277/24 E). Only OPTOTRONIC® drivers that can be connected in parallel on the output side are marked with the symbol below.

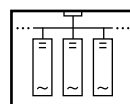

Symbol indicating that drivers can be connected in parallel on the output side

### Output switching (switching between driver and module)

Typically, OPTOTRONIC® constant-current drivers are not switched on the output side during operation. Only a few SELV Compact LED drivers such as OTi DALI and OT FIT having the hot-plug function allow this way of switching to the LED module. Non-isolated drivers do not allow this when voltage is applied.

### OSRAM SELV drivers: OTi DALI SELV and OT FIT SELV



### Temperature and lifetime

The lifetime of OPTOTRONIC® drivers is determined by the lifetime of the used electronic components and their individual electric and thermal loading. Every OPTOTRONIC® driver is marked with a so-called  $T_c$  point. For safe operation, it is mandatory that the temperature at the  $T_c$  point does not exceed the specified maximum temperature. This also ensures that OPTOTRONIC® drivers typically achieve a nominal lifetime of 50 000 hours at a maximum failure rate of 10 %.

When installing an LED driver outside of a luminaire, make sure not to install it too close to any other heat source in order to avoid overheating. The exponential dependency of the lifetime on temperature, however, also means that the lifetime of an LED driver can be extended by operating it below the specified maximum temperature at the  $T_c$  point at all times. As a rule of thumb, you can expect up to double the lifetime for OPTOTRONIC® drivers when the temperature at the  $T_c$  point is kept 10 °C below the maximum permitted temperature at all times. The diagram on the right shows the typical life expectancy of an OPTOTRONIC® driver (with a nominal lifetime of 50 000 hours at a maximum  $T_c$  temperature of 75 °C) at various  $T_c$  temperatures.

### Expected lifetime of OPTOTRONIC® drivers

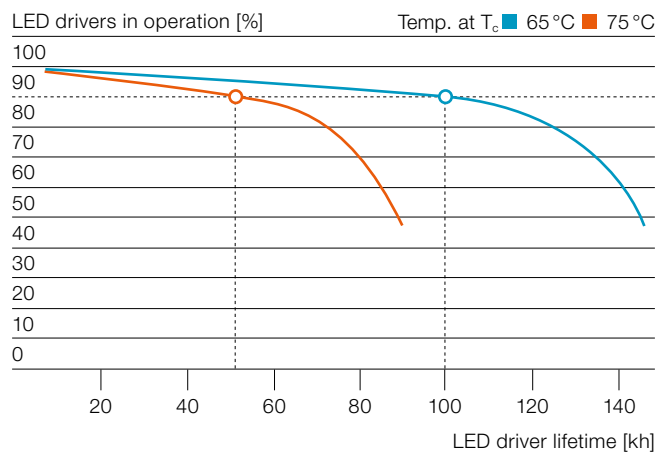

**Audible noise**

The frequency-dependent sound pressure level generated by an OPTOTRONIC® driver approximates the audibility threshold, i.e. a person with normal hearing is virtually not able to notice the noise generated by an OPTOTRONIC® driver in a room. The overall sound pressure level is determined by the sound power level of the unit, the number of units in operation and the absorption properties of the room.

**Note:** For LED drivers where the mains voltage deviates significantly from a sine wave, a “chirping” sound may be heard from the choke coils in the driver’s input stage.

To avoid noise from dimming, dimmable OPTOTRONIC® drivers should be installed in a way that prevents the transfer of vibrations to any resonance surface.

**Permitted switching cycles and use of motion/presence detectors**

OPTOTRONIC® constant-current LED drivers and OSRAM LED modules are specified for a minimum of 100 000 switching cycles. This means that when switching 50 times a day (about 18 000 switching cycles per year), a minimum of 5 years of reliable operation is possible with OSRAM systems in areas with more frequent switching, such as car parks, corridors, lifts and logistic areas.

Internal tests by OSRAM have even shown much higher possible switching cycles without any failure of the tested OPTOTRONIC® drivers and OSRAM LED modules. An additional benefit of the LED solution is the fact that a minimum “burn-in” time – as with fluorescent lamps – is not necessary.

**Permitted switching cycles per LED driver families**

Number of LED driver switching cycles	LED driver reference	LED driver reference	Comment
> 1 000 000	DALI LED driver OPTOTRONIC® Intelligent DALI	OTi DALI ...	DALI driver in stand-by mode, switching via DALI commands
> 150 000	DALI LED driver OPTOTRONIC® Intelligent DALI Window driver OPTOTRONIC® Intelligent	OTi DALI ... OTi ...	Switching on the primary side ON/OFF
> 150 000	LED driver OPTOTRONIC® FIT with 3 currents or fixed output	OT FIT ... CS/OT FIT ...	Switching on the primary side ON/OFF
> 100 000	LED driver OPTOTRONIC® ECO	OTe/OTe PC (Phase Cut)	Switching on the primary side ON/OFF
> 20 000	Constant-voltage drivers	OT 24 V or OT 12 V	Switching on the primary side ON/OFF

For applications where a higher number of switching cycles is required, OSRAM recommends the use of OPTOTRONIC® DALI LED drivers, which are permanently in stand-by mode (on mains voltage) and only switch with the DALI commands (0\* = 0 % luminous flux and 254 = 100 % luminous flux) or other required light levels. Because of this, no ON/OFF switchings of the driver and no inrush currents can influence the lifetime of the DALI LED driver or LED module. This operating mode therefore allows 1 000 000 switching cycles.

Another option to use DALI LED drivers is in corridors – with a low permanent light level of 5–10 % for orientation and a light level of 100 % when presence is detected.

**Possible DALI solution for corridor application: DALIeco in corridor function mode (2 alternating light levels)**

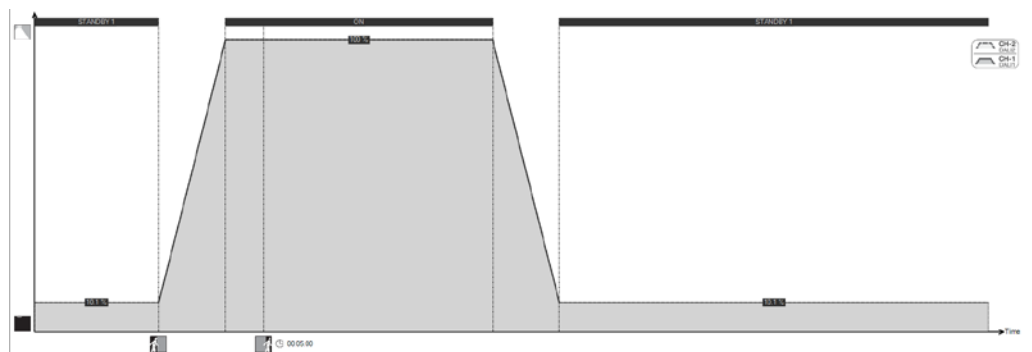
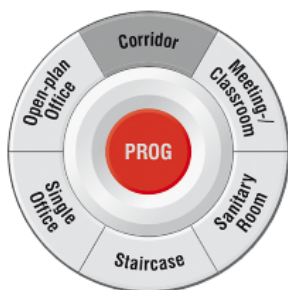

For more details about DALIeco, please see: [www.osram.com/dalieco](http://www.osram.com/dalieco).

\* DALI dimming value



# Technical application guide OPTOTRONIC® LED drivers for indoor application

14 Standards for LED drivers,  
LED modules and LED luminaires

### General information on standards

All OPTOTRONIC® drivers are designed to meet or exceed applicable standards for their use in lighting applications.

### Safety

The safety requirements for LED drivers are defined in EN 61347-2-13.

OPTOTRONIC® indoor drivers are available in two insulation classes:

- SELV drivers (double/reinforced isolation between input and output, LEDset)
- Non-isolated drivers (no isolation between input and output, LEDset)

OPTOTRONIC® LED drivers have the following safety features:

- Overload protection
- Short-circuit protection
- Partial-load/no-load-safe
- Overtemperature operation
- Input overvoltage and surge protection

### Performance

The performance standard EN 62384 defines the optimal operation of LEDs with LED drivers, ensuring that LEDs are only operated within their specified operating parameters. This guarantees best light quality and maximum lifetime of suitable LED modules. All OPTOTRONIC® drivers with the ENEC mark are approved according to EN 62384.

### EMC (electromagnetic compatibility)

EMC is specified as a series of different test criteria. These are radio interference suppression (EMI), immunity to interference and voltage fluctuations, flicker and harmonic content (up to the 39th harmonic).

### Harmonic content of the mains current

Lighting equipment is subjected to restrictions on harmonics. The maximum permissible limits are defined in the standard EN 61000-3-2, classification in class C for lighting equipment. All OPTOTRONIC® drivers fulfill the strict harmonic limits below 25 W and above 25 W, even though LED products below 25 W are excluded from the requirements. This means that OPTOTRONIC® drivers already fulfill the upcoming stricter requirements for LED products below 25 W. This is important even for large installations because it does not matter if 1 000 low-wattage luminaires or 250 high-wattage luminaires have to be installed.

### Immunity

The immunity requirements are specified in EN 61547. This guarantees protection against interference from external high-frequency fields, discharge of static electricity and transient overvoltages on the mains supply.

### Radio interference

The requirements, e.g. limits for conductive and radiated disturbances, are defined in EN 55015. The length of output cables must not exceed the values specified in the product datasheets to meet the requirements of radio interference suppression.

**Note:** The luminaire manufacturer is responsible for measuring and verifying EMI compliance of the complete luminaire as the level of radio interference will vary depending on the luminaire construction. Especially primary and secondary cable lengths and their routing may have a significant effect on radio interference.

### EC directives

#### EC directive

<b>Low-voltage directive 2006/95/EC</b>	Product-related safety standards Photobiological safety, EMF standard
<b>Electromagnetic compatibility 2004/108/EC</b>	EMC standards: EMI, immunity, harmonics and flicker
<b>Energy-related products 2009/125/EC (ecodesign)</b>	Requirements in the directive
<b>Hazardous substances 2011/65/EU (ROHS, REACH)</b>	Requirements in the directive

## Standards for LED products

### Drivers for LED modules

	International	Europe
<b>Safety driver</b>	IEC 61347-2-13	EN 61347-2-13
<b>Safety luminaires<sup>1)</sup></b>	IEC 60598-1	EN 60598-1
<b>Performance</b>	IEC 62384	EN 62384
<b>EMC – electromagnetic interference (EMI)</b>	CISPR 15	EN 55015
<b>EMC – immunity</b>	IEC 61547	EN 61547
<b>EMC – harmonics</b>	IEC 61000-3-2	EN 61000-3-2
<b>EMC – flicker</b>	IEC 61000-3-3	EN 61000-3-3
<b>EMF (electromagnetic fields)<sup>1)</sup></b>	IEC 62493	EN 62493

1) Independent LED driver

### LED modules

	International	Europe
<b>Safety LED modules<sup>4)</sup></b>	IEC 62031	EN 62031
<b>Safety luminaires<sup>3)</sup></b>	IEC 60598-1	EN 60598-1
<b>EMC – electromagnetic interference (EMI)<sup>1)</sup></b>	CISPR 15	EN 55015
<b>EMC – immunity<sup>1)2)</sup></b>	IEC 61547	EN 61547
<b>EMC – harmonics<sup>1)</sup></b>	IEC 61000-3-2	EN 61000-3-2
<b>EMC – flicker<sup>1)</sup></b>	IEC 61000-3-3	EN 61000-3-3
<b>Performance</b>	IEC 62717	–
<b>EMF (electromagnetic fields)<sup>1)3)</sup></b>	IEC 62493	EN 62493
<b>Photobiological safety<sup>4)</sup></b>	IEC 62471	EN 62471

1) LED modules with built-in driver

2) LED modules with external driver, ESD and immunity tests (high energy pulses L-N, PE) apply

3) Independent LED modules or if parts are accessible (outside of the luminaire)

4) Test for photobiological safety included in safety standard 62031

### LED luminaires

	International	Europe
<b>Safety luminaires – general requirements</b>	IEC 60598-1	EN 60598-1
<b>Safety luminaires – additional requirements</b>	IEC 60598-2-xx special luminaires	EN 60598-2-xx special luminaires
<b>Performance</b>	IEC 62722-2-1	–
<b>EMC – electromagnetic interference (EMI)</b>	CISPR 15	EN 55015
<b>EMC – immunity</b>	IEC 61547	EN 61547
<b>EMC – harmonics</b>	IEC 61000-3-2	EN 61000-3-2
<b>EMC – flicker</b>	IEC 61000-3-3	EN 61000-3-3
<b>EMF (electromagnetic fields)</b>	IEC 62493	EN 62493
<b>Photobiological safety</b>	IEC 62471	EN 62471

#### Disclaimer

All information contained in this document has been collected, analyzed and verified with great care by OSRAM. However, OSRAM is not responsible for the correctness and completeness of the information contained in this document and OSRAM cannot be made liable for any damage that occurs in connection with the use of and/or reliance on the content of this document. The information contained in this document reflects the current state of knowledge on the date of issue.

**OSRAM GmbH**  
**Headquarters Germany**  
Phone: +49 89 6213-0  
E-mail: contact@osram.com

**OSRAM a.s Office Austria**  
Phone: +43 1 250 24  
E-mail: info@osram.at

**OSRAM Benelux B.V.**  
**Netherlands**  
Phone: +31 (0) 88 750 8800  
E-mail: osram@osram.nl

**Belgium**  
Phone: +32 (0) 2 588 49 51  
E-mail: osram@osram.be

**OSRAM Sales EOOD Bulgaria**  
Phone: +359 32 348 110  
E-mail: sales-sofia@osram.com

**OSRAM d.o.o. Croatia**  
Phone: +385 1 3032-023  
E-mail: osram@osram.hr

**OSRAM Ceska republika s.r.o.**  
**Czech Republic**  
Phone: +42 0 554 793 111  
E-mail: osram@osram.cz

**OSRAM A/S Denmark**  
Phone: +45 43 30 20 40

**OSRAM Oy Finland**  
Phone: +358 9 8493 2200  
E-mail: asiakaspalvelu@osram.fi

**Baltic DS/OSRAM Oy Finland:**  
**Estonia, Latvia and Lithuania**  
Phone: +358 9 8493 2200  
E-mail: customerservice@osram.fi

**OSRAM Lighting Middle East FZE**  
**Dubai – United Arab Emirates**  
Phone: +971 4 523 1777  
E-mail: ds-mea@osram.com

**OSRAM Lighting SASU France**  
Phone: +33 3 68 41 89 33  
E-mail: oem@osram.fr

**OSRAM Limited Great Britain**  
Phone: +44 1925 273 360  
E-mail: oem@osram.com

**OSRAM a.s. Magyarországi**  
**Fióktelepe Hungary**  
Phone: +36 1 225 30 55  
E-mail: info@osram.hu

**OSRAM SpA Società Riunite**  
**OSRAM Edison Clerici Italy**  
Phone: +39 02 424 91  
E-mail: oemcentroservizi@osram.com

**OSRAM Lighting AS Norway**  
Phone: +47 40 00 40 14

**OSRAM North Africa S.a.r.l.**  
E-mail: contact@osram.com

**OSRAM (Pty.) Ltd. South Africa**  
Phone: +27 10 221 40 00

**OSRAM Sp. z.o.o. Poland**  
Phone: +48 22 376 57 00  
E-mail: biuro.pl@osram.pl

**OSRAM LDA**  
**Portugal, Açores, Madeira**  
Phone: +351 21 033 22 10  
E-mail: osram@osram.pt

**OSRAM OOO Russia DS**  
Phone: +7 (499) 649-7070  
E-mail: ds-russia@osram.com

**OSRAM Romania S.R.L.**  
Phone: +40 (21) 232 85 61  
E-mail: osram\_ro@osram.com

**OSRAM, a.s. Slovak Republic**  
Phone: +421 35 64 64 473  
E-mail: contact@osram.com

**OSRAM a.s. Slovenia**  
Phone: +43 1 250 24  
E-mail: info@osram.at

**OSRAM Lighting S.L. Spain**  
Phone: +34 91 491 52 17  
E-mail: marketing-ds@osram.com

**OSRAM AB Sweden**  
Phone: +46 128 70 400  
E-mail: info@osram.se

**OSRAM Lighting AG Switzerland**  
Phone: +41 52 555 25 55  
E-mail: info.ch@osram.com

**OSRAM Teknolojileri Ticaret A.S.**  
**Turkey**  
Phone: +90 212 703 43 00  
E-mail: contact@osram.com

OSRAM GmbH

Headquarters Germany:

Marcel-Breuer-Strasse 6  
80807 Munich, Germany  
Phone +49 89 6213-0  
Fax +49 89 6213-2020  
www.osram.com

**OSRAM**